

N-CHANNEL ENHANCEMENT MODE FIELD MOSFET
Product Summary

V_{SS}	$R_{SS(ON)} \text{ Max}$	I_S $T_A = +25^\circ\text{C}$
24V	36m Ω @ $V_{GS} = 4.5\text{V}$	5A

Description and Applications

This new generation MOSFET is designed to minimize the on-state resistance ($R_{SS(ON)}$) and making it ideal for high efficiency power management.

- Battery Management
- Load Switch
- Battery Protection

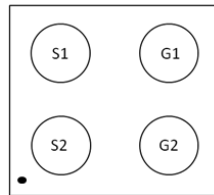

Top View

Features and Benefits

- Built-in G-S Protection Diode against ESD 2kV HBM
- **Totally Lead-Free & Fully RoHS Compliant (Notes 1 & 2)**
- **Halogen and Antimony Free. "Green" Device (Note 3)**

Mechanical Data

- Case: X2-WLB1616-4
- Moisture Sensitivity: Level 1 per J-STD-020
- Terminal Connections: See Diagram
- Terminal Material: SnAgCu Ball
- Weight: 0.0023 grams (Approximate)

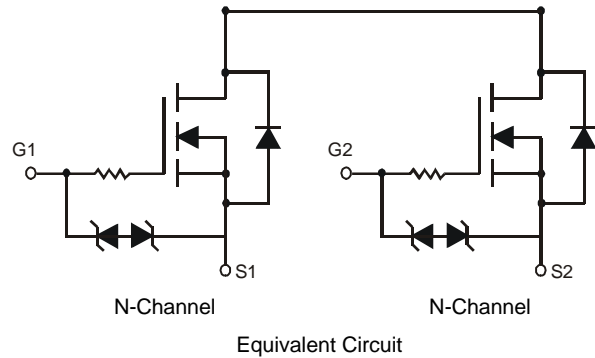
Ordering Information (Note 4)

Part Number	Case	Packaging
DMN2036UCB4-7	X2-WLB1616-4	3000/Tape & Reel

- Notes:
1. No purposely added lead. Fully EU Directive 2002/95/EC (RoHS), 2011/65/EU (RoHS 2) & 2015/863/EU (RoHS 3) compliant.
 2. See <https://www.diodes.com/quality/lead-free/> for more information about Diodes Incorporated's definitions of Halogen- and Antimony-free, "Green" and Lead-free.
 3. Halogen- and Antimony-free "Green" products are defined as those which contain <900ppm bromine, <900ppm chlorine (<1500ppm total Br + Cl) and <1000ppm antimony compounds.
 4. For packaging details, go to our website at <https://www.diodes.com/design/support/packaging/diodes-packaging/>.

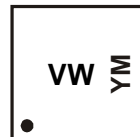
Marking Information

VW/VW = Product Type Marking Code
 YM = Date Code Marking
 Y = Year (ex: F = 2018)
 M = Month (ex: 9 = September)

Date Code Key

Year	2015	2016	2017	2018	2019	2020	2021
Code	C	D	E	F	G	H	I

Month	Jan	Feb	Mar	Apr	May	Jun	Jul	Aug	Sep	Oct	Nov	Dec
Code	1	2	3	4	5	6	7	8	9	O	N	D

Maximum Ratings

Characteristic			Symbol	Value	Unit
Source-Source Voltage			V_{SSS}	24	V
Gate-Source Voltage			V_{GSS}	± 12	V
Continuous Source Current @ $T_A = +25^\circ\text{C}$ (Note 5)	Steady State	$T_A = +25^\circ\text{C}$	I_S	5.0	A
		$T_A = +70^\circ\text{C}$		4.0	
Pulsed Source Current @ $T_A = +25^\circ\text{C}$ (Notes 5 & 6)			I_{SM}	30	A

Thermal Characteristics

Characteristic			Symbol	Value	Unit
Power Dissipation, @ $T_A = +25^\circ\text{C}$ (Note 5)			P_D	1.45	W
Thermal Resistance, Junction to Ambient @ $T_A = +25^\circ\text{C}$ (Note 5)			$R_{\theta JA}$	86.68	$^\circ\text{C/W}$
Operating and Storage Temperature Range			T_J, T_{STG}	-55 to +150	$^\circ\text{C}$

Electrical Characteristics (@ $T_A = +25^\circ\text{C}$, unless otherwise specified.)

Characteristic	Symbol	Min	Typ	Max	Unit	Test Condition
OFF CHARACTERISTICS (Note 7)						
Source to Source Breakdown Voltage $T_J = +25^\circ\text{C}$	$V_{(BR)SS}$	24	—	—	V	$I_S = 1\text{mA}, V_{GS} = 0\text{V}$
Zero Gate Voltage Source Current $T_J = +25^\circ\text{C}$	I_{SSS}	—	—	1.0	μA	$V_{SS} = 20\text{V}, V_{GS} = 0\text{V}$
Gate-Body Leakage	I_{GSS}	—	—	± 10	μA	$V_{GS} = \pm 8\text{V}, V_{SS} = 0\text{V}$
ON CHARACTERISTICS (Note 7)						
Gate Threshold Voltage	$V_{GS(TH)}$	0.5	—	1.3	V	$V_{SS} = 10\text{V}, I_S = 1.0\text{mA}$
Static Source-Source On-Resistance	$R_{SS(ON)}$	20	29	36	m Ω	$V_{GS} = 4.5\text{V}, I_S = 3.0\text{A}$
		20.5	30	37		$V_{GS} = 4.0\text{V}, I_S = 3.0\text{A}$
		21	31	39		$V_{GS} = 3.7\text{V}, I_S = 3.0\text{A}$
		22	33	44		$V_{GS} = 3.1\text{V}, I_S = 3.0\text{A}$
		23	36	52		$V_{GS} = 2.5\text{V}, I_S = 3.0\text{A}$
Forward Transfer Admittance	$ Y_{fs} $	—	9.4	—	S	$V_{SS} = 10\text{V}, I_S = 3.0\text{A}$
Body Diode Forward Voltage	$V_{F(S-S)}$	—	0.8	1.2	V	$I_F = 3.0\text{A}, V_{GS} = 0\text{V}$
DYNAMIC CHARACTERISTICS (Note 8)						
Total Gate Charge	Q_g	—	12.6	—	nC	$V_{GS} = 4.5\text{V}, V_{SS} = 10\text{V}, I_S = 6\text{A}$
Turn-On Delay Time	$t_{D(ON)}$	—	183	—	ns	$V_{DD} = 10\text{V},$ $R_L = 3.33\Omega, I_S = 3.0\text{A}$
Turn-On Rise Time	t_R	—	278	—	ns	
Turn-Off Delay Time	$t_{D(OFF)}$	—	738	—	ns	
Turn-Off Fall Time	t_F	—	572	—	ns	

- Notes:
- Device mounted on FR-4 material with 1-inch² (6.45-cm²), 2-oz. (0.071-mm thick) Cu.
 - Repetitive rating, pulse width limited by junction temperature.
 - Short duration pulse test used to minimize self-heating effect.
 - Guaranteed by design. Not subject to production testing.

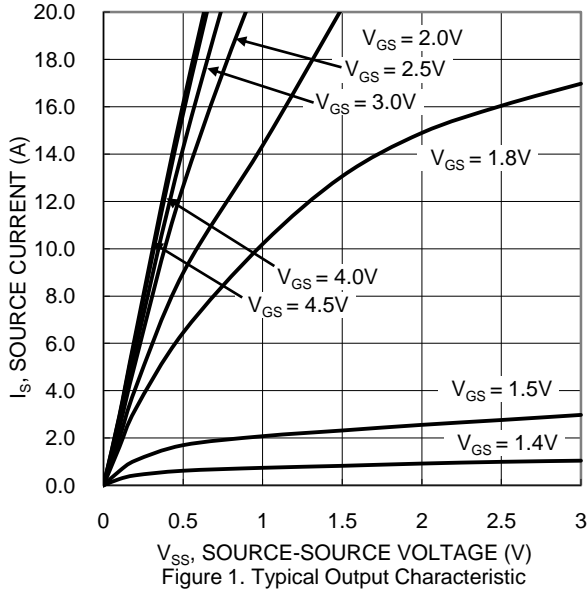

Figure 1. Typical Output Characteristic

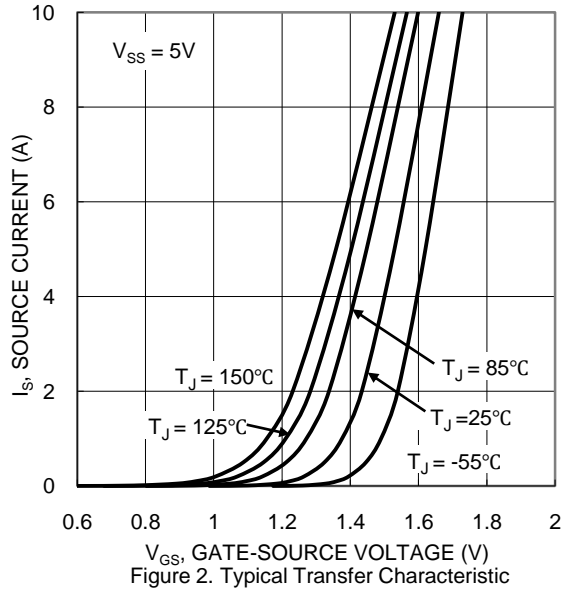

Figure 2. Typical Transfer Characteristic

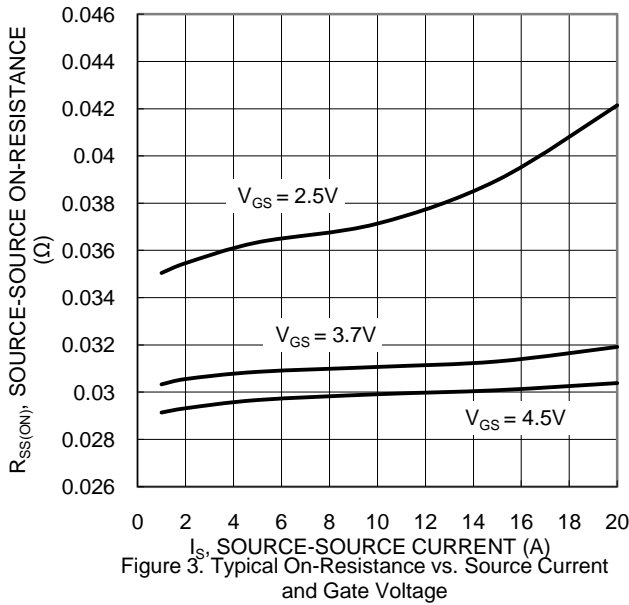

Figure 3. Typical On-Resistance vs. Source Current and Gate Voltage

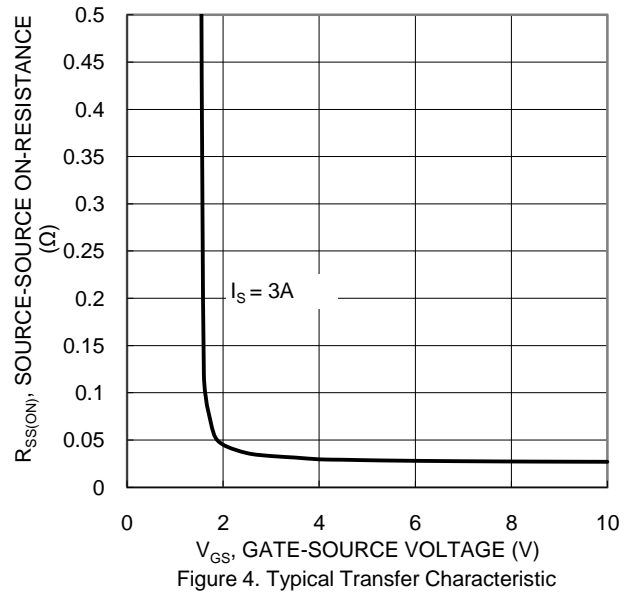

Figure 4. Typical Transfer Characteristic

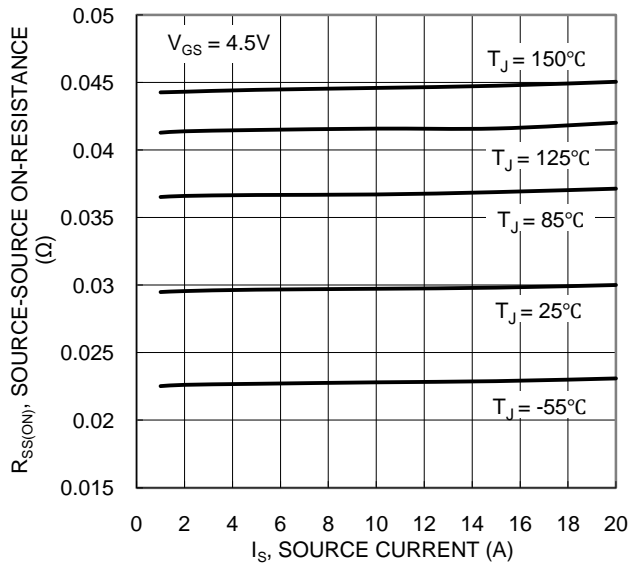

Figure 5. Typical On-Resistance vs. Source Current and Junction Temperature

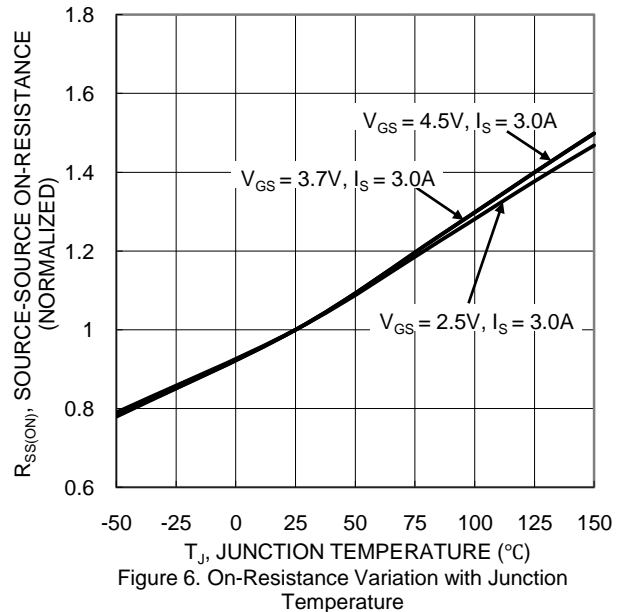
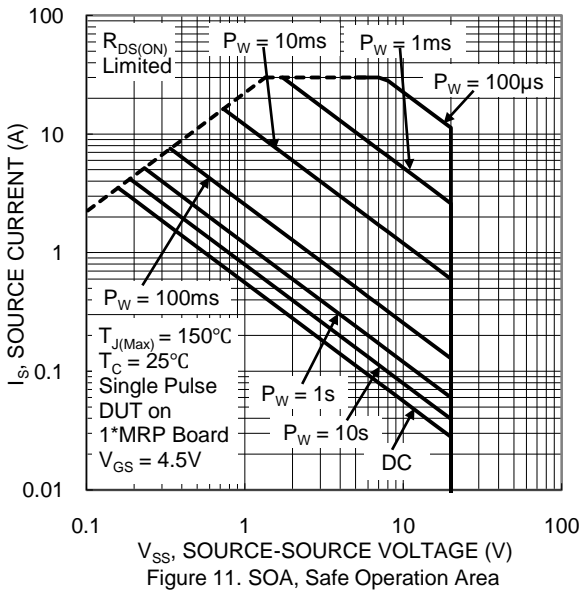
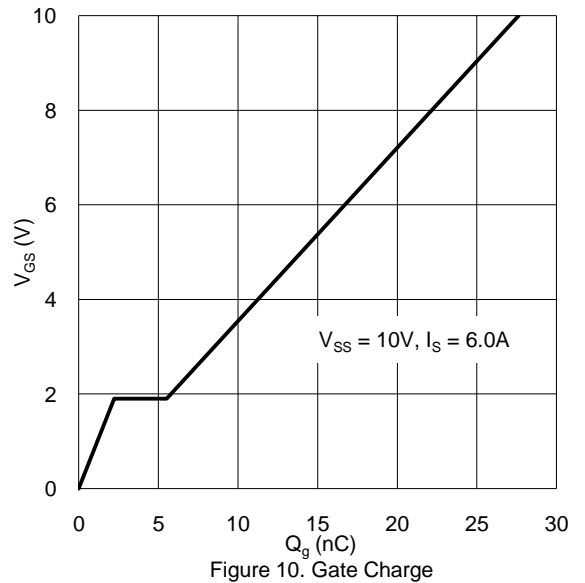
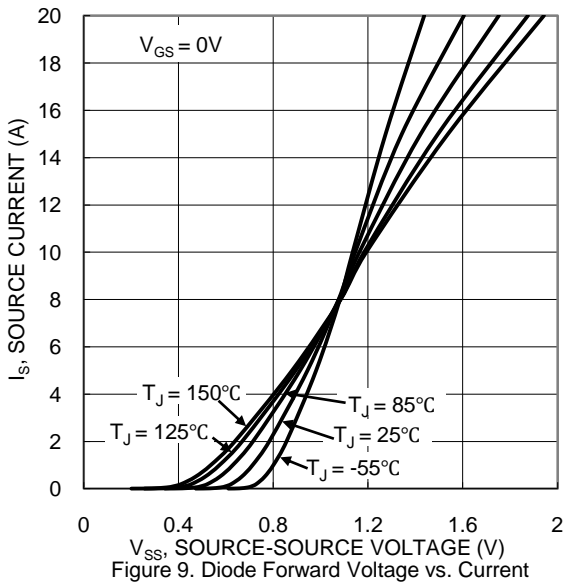
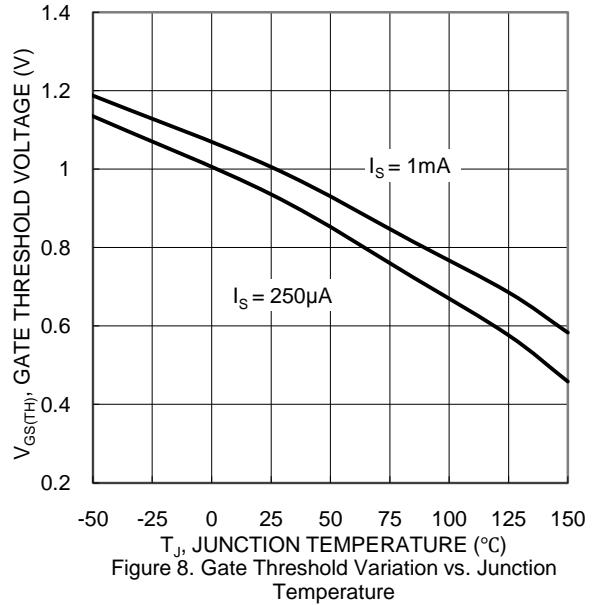
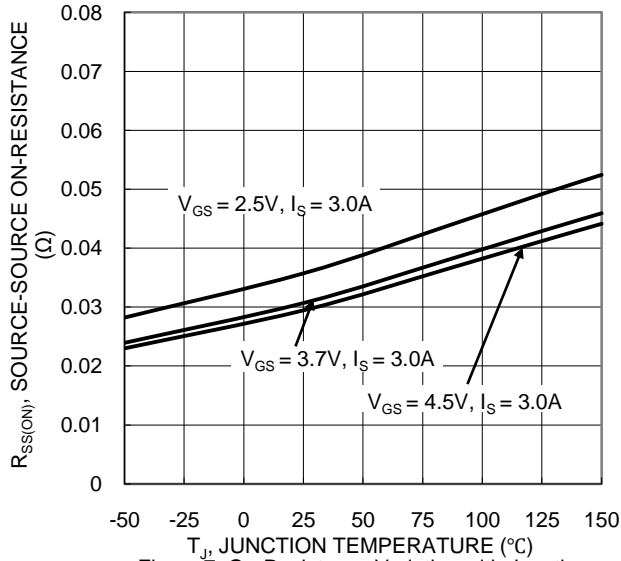

Figure 6. On-Resistance Variation with Junction Temperature



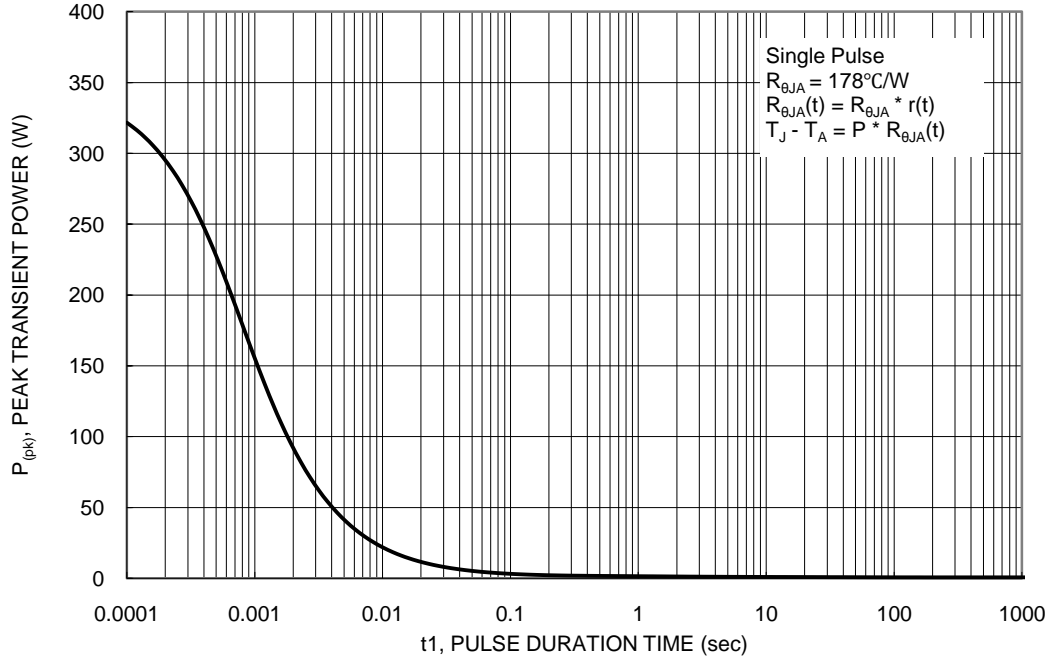

Figure 12. Single Pulse Maximum Power Dissipation

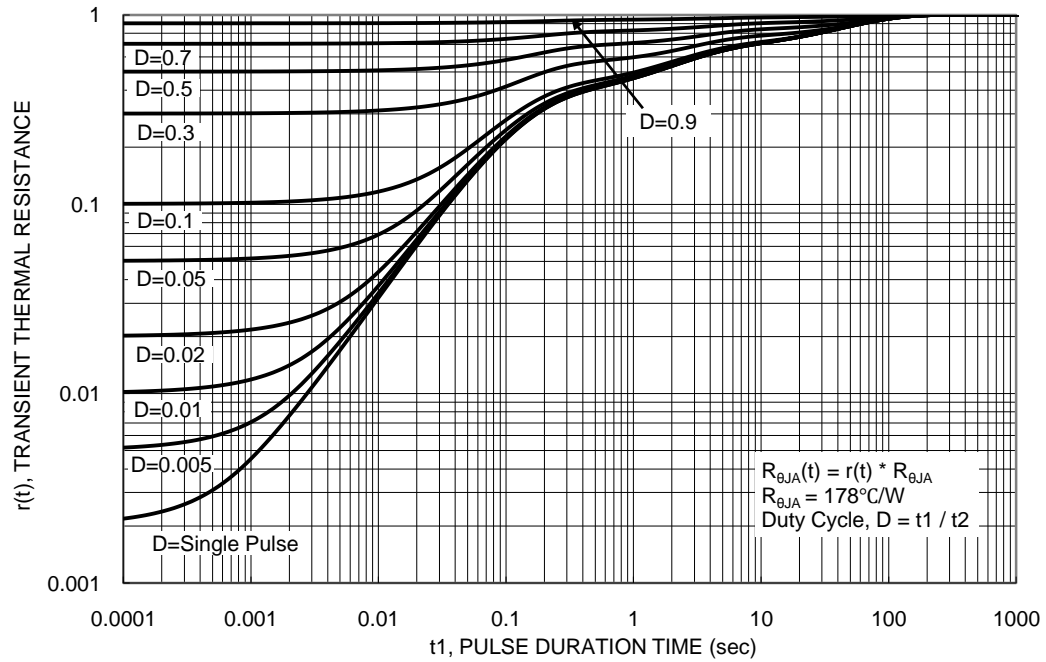
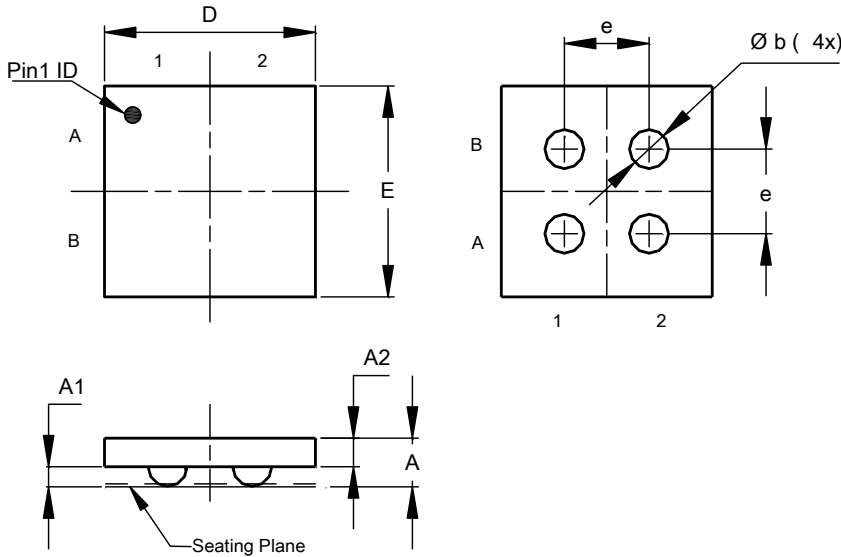

Figure 13. Transient Thermal Resistance

Package Outline Dimensions

Please see <http://www.diodes.com/package-outlines.html> for the latest version.

X2-WLB1616-4



X2-WLB1616-4			
Dim	Min	Max	Typ
A	--	0.40	0.37
A1	--	--	0.15
A2	--	--	0.22
b	0.25	0.35	0.30
D	1.58	1.66	1.62
E	1.58	1.66	1.62
e	-	-	0.65
All Dimensions in mm			

Suggested Pad Layout

Please see <http://www.diodes.com/package-outlines.html> for the latest version.

X2-WLB1616-4

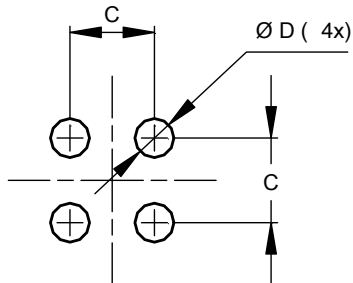

Dimensions	Value (in mm)
C	0.65
D	0.30

IMPORTANT NOTICE

DIODES INCORPORATED MAKES NO WARRANTY OF ANY KIND, EXPRESS OR IMPLIED, WITH REGARDS TO THIS DOCUMENT, INCLUDING, BUT NOT LIMITED TO, THE IMPLIED WARRANTIES OF MERCHANTABILITY AND FITNESS FOR A PARTICULAR PURPOSE (AND THEIR EQUIVALENTS UNDER THE LAWS OF ANY JURISDICTION).

Diodes Incorporated and its subsidiaries reserve the right to make modifications, enhancements, improvements, corrections or other changes without further notice to this document and any product described herein. Diodes Incorporated does not assume any liability arising out of the application or use of this document or any product described herein; neither does Diodes Incorporated convey any license under its patent or trademark rights, nor the rights of others. Any Customer or user of this document or products described herein in such applications shall assume all risks of such use and will agree to hold Diodes Incorporated and all the companies whose products are represented on Diodes Incorporated website, harmless against all damages.

Diodes Incorporated does not warrant or accept any liability whatsoever in respect of any products purchased through unauthorized sales channel. Should Customers purchase or use Diodes Incorporated products for any unintended or unauthorized application, Customers shall indemnify and hold Diodes Incorporated and its representatives harmless against all claims, damages, expenses, and attorney fees arising out of, directly or indirectly, any claim of personal injury or death associated with such unintended or unauthorized application.

Products described herein may be covered by one or more United States, international or foreign patents pending. Product names and markings noted herein may also be covered by one or more United States, international or foreign trademarks.

This document is written in English but may be translated into multiple languages for reference. Only the English version of this document is the final and determinative format released by Diodes Incorporated.

LIFE SUPPORT

Diodes Incorporated products are specifically not authorized for use as critical components in life support devices or systems without the express written approval of the Chief Executive Officer of Diodes Incorporated. As used herein:

A. Life support devices or systems are devices or systems which:

1. are intended to implant into the body, or
2. support or sustain life and whose failure to perform when properly used in accordance with instructions for use provided in the labeling can be reasonably expected to result in significant injury to the user.

B. A critical component is any component in a life support device or system whose failure to perform can be reasonably expected to cause the failure of the life support device or to affect its safety or effectiveness.

Customers represent that they have all necessary expertise in the safety and regulatory ramifications of their life support devices or systems, and acknowledge and agree that they are solely responsible for all legal, regulatory and safety-related requirements concerning their products and any use of Diodes Incorporated products in such safety-critical, life support devices or systems, notwithstanding any devices- or systems-related information or support that may be provided by Diodes Incorporated. Further, Customers must fully indemnify Diodes Incorporated and its representatives against any damages arising out of the use of Diodes Incorporated products in such safety-critical, life support devices or systems.

Copyright © 2018, Diodes Incorporated

www.diodes.com