

Model No: FSL-1020R02-08  
 Product Line: Tymphany

Rev: 1  
 Last Update: 2017-04-21 12:39:42

## Product Description

This 10 inch 8 ohm speaker features a FEA optimized ferrite magnet motor, a 2 inch high-temperature voice coil, a vented yoke for motor cooling, and a high strength stamped steel frame. It also features a Kevlar loaded non-pressed paper cone to help dampen and control cone resonance. The multi-roll surround and spider have been optimized to reduce distortion over the excursion range of this transducer.



## Mechanical Drawing

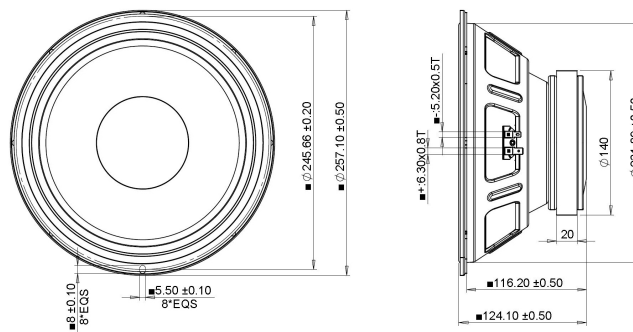

## Specifications

DC Resistance	Revc	Ohms	5.93	5.0%	Energy Bandwidth Product	EBP	(1/Qes)*fs
Minimum Impedance	Zmin	Ohms	7.98	7.5%	Moving Mass	Mms	g
Voice Coil Inductance	Le	mH	0.66		Suspension Compliance	Cms	um/N
Resonant Frequency	Fs	Hz	67.69	15%	Effective Cone diameter	D	cm
Mechanical Q Factor	Qms		4.52		Effective Piston Area	Sd	cm <sup>2</sup>
Electrical Q Factor	Qes		0.41		Effective Volume	Vas	L
Total Q Factor	Qts		0.37		Motor Force Factor	BL	Tm
Ratio Fs/Qts	F	Fs/Qts	182.44		Motor Efficiency Factor	$\beta$	(T*M <sup>2</sup> )/Ohms
Half Space Sensitivity @2.83V	db@2.83V/1M	dB	96.46	+/- 1.0db	Voice coil former Material	VCfm	KSV
Half Space Sensitivity @1W/1M	db@1W/1M	dB	96.4	+/- 1.0db	Voice coil inner diameter	VCd	mm
Gap Height	Gh	mm	8		Rated Noise Power	P	W
Maximum Linear Excursion	Xmax	mm	2.4		Test Spectrum Bandwidth		70Hz-700Hz
Ferrofluid Type	FF				Driver Size	Inch	10 in
Driver Mass	Kg		3.5				

## Frequency and Impedance Response



Highcharts.com