

5

4



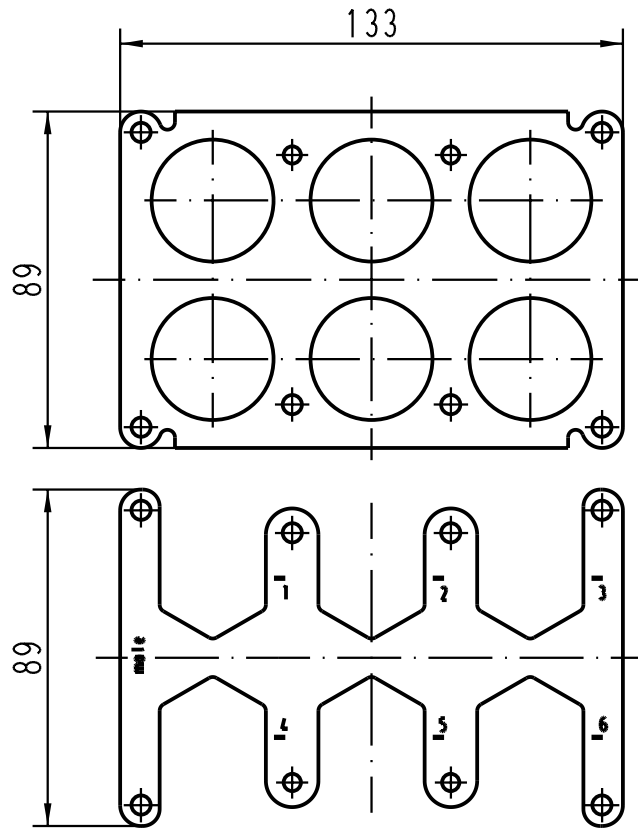

3

2

1



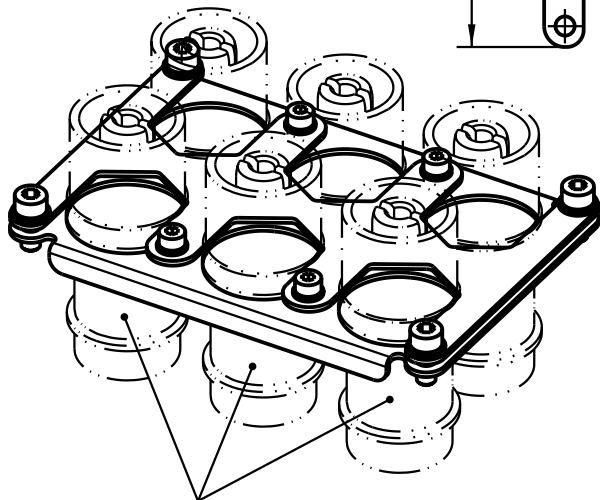

lose mitgeliefert:/
separately enclosed:

-  4x Sechskantmutter M4/
4x nut M4
-  8x Sperrkantscheibe SK S4/
8x washer M4
-  4x Zylinderschraube M4x10 (SW3)/
4x fillister head cap screw M4x10 (SW3)
-  4x Sperrkantscheibe SK S5/
4x washer M5
-  4x Zylinderschraube M5x12 (SW4)/
4x fillister head cup screw M5x12 (SW4)

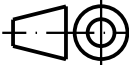

nicht im Lieferumfang enthalten/
not range of delivery

 All Dimensions in mm Original Size DIN A 4	Techn. Character.			Nicht tolerierte Masse/ Free size tolerances	
		Dat.	Name	Massstab/Scale	
	Detail.	11.03.04	Loe.	1:2	
	Insp.		KR		
	Stand.				
410926	HARTING Electric GmbH & Co. KG			TB 09 40 048 9806	
Mod.	Dat.	Name	D-32339 Espelkamp		
					
				Sub.	
					Blatt/ page