

Evaluation Board Manual

FEATURES

- Wide Input Voltage Range 4.5V – 29V
- 2 Amps Max Continuous Output Current
- Internal Compensation
- Input Feedforward Control improves Transient Response and Regulation
- 1200kHz Constant Frequency Operation
- Low 0.2V Reference Voltage
- High output setpoint accuracy of 2.5%
- PWM Dimming Capable
- Small SO8-EP Thermally Enhanced Package
- Lead Free, RoHS Compliant Package

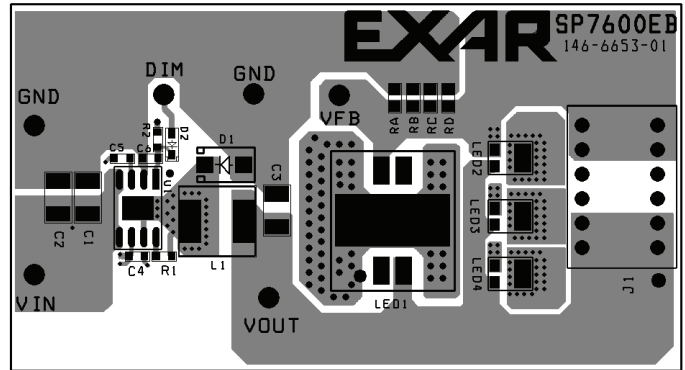

DESCRIPTION

The **SP7600 Evaluation Board** is designed to help the user evaluate the performance of the SP7600 for use as a LED Driver. The evaluation board is a completely assembled and tested surface mount board which provides easy probe access points to all SP7600 inputs and outputs so that the user can quickly connect and measure electrical characteristics and waveforms. The Evaluation Board schematic diagram is shown in Figure 1.

BOARD SCHEMATIC

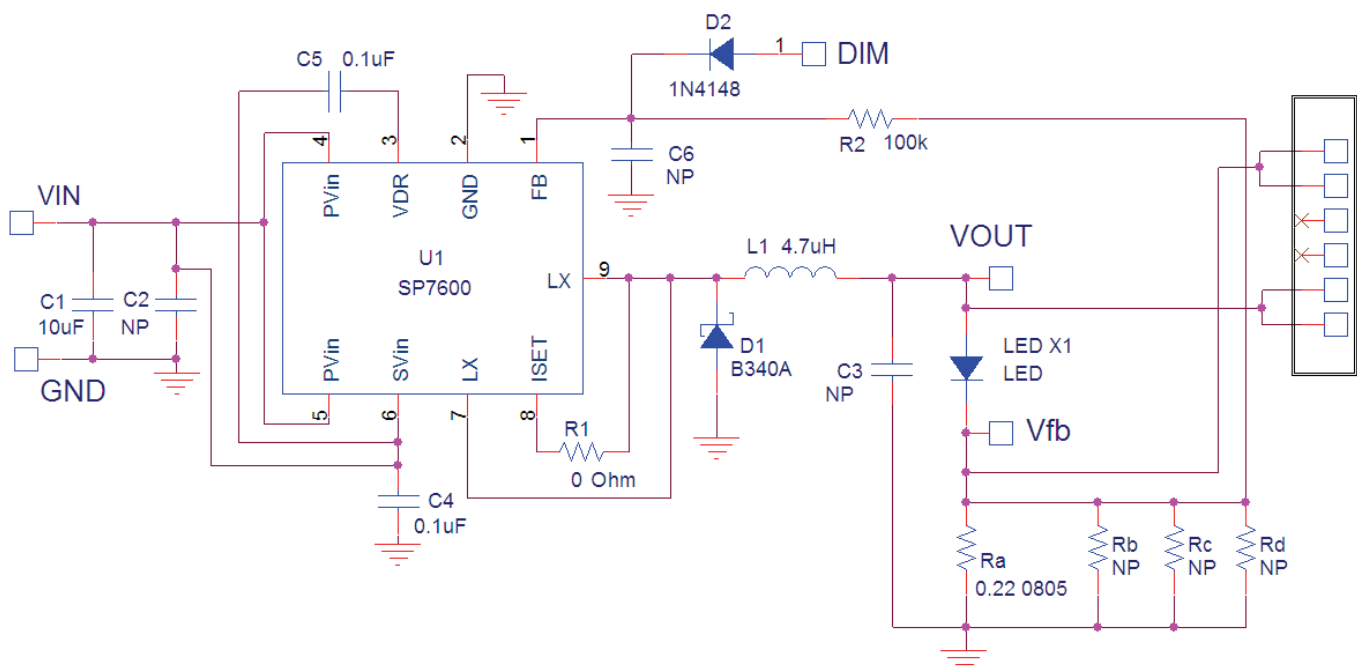

Figure 1. The SP7600 Evaluation Board Schematic Diagram

1) Powering Up the SP7600 Circuit

The SP7600 Evaluation Board can be powered from a 4.5V to 29V power supply. Connect the power supply with short leads directly to the “Vin” and “GND” posts.

2) Setting the output current

Externally connected LEDs need to be connected anode to the VOUT pin and cathode to the Vfb pin. As many as 6 series connected LEDs may be used, depending on the input voltage range available. The maximum output current is 3A but the user should take care not to exceed the maximum junction temperature, 125°C. Up to 2A maximum is possible in almost all conditions. The board also has SMT pads available for LEDs to be mounted in the LED1 position for a Luxeon K2 LED, and LED2, LED3 and LED4 positions for Luxeon Rebel LEDs. The total output current of the SP7600 is controlled by the VFB pin voltage setpoint of 200mV. Use a resistor at RA to set the output current by the formula:

$$I_{out} = V_{fb}/R_A$$

where RA is the parallel combination of Ra and any of the resistors Rb, Rc or Rd.

If Ra, Rb, Rc and Rd are used then $R_A = 1/(1/R_a + 1/R_b + 1/R_c + 1/R_d)$

Standard SP7600EB Evaluation Board Example:

$$I_{out} = V_{fb}/R_A = 200\text{mV}/0.22\text{ohm} = 1\text{A}$$

3) Dimming

The SP7600 can be pulse width modulated using a signal applied to the DIM post. The DIM signal connects to the VFB pin through a 1N4148 diode and will shutdown the SP7600 when DIM = H and turn-on the SP7600 when DIM = L. The DIM signal needs to be greater than 600mV minimum to turn-off the SP7600 and less than 200mV to fully turn-on the SP7600. It is recommended to use a signal with DIM = 1V or more for OFF and 0V for ON. The user should note that the logic is reversed relative to many other PWM controlled LED drivers. In other words a logic level high at 20% duty cycle will result in approximately an 80% duty cycle for the LED. Recommended modulation frequencies are from 100Hz to 200Hz with 10 – 90% duty cycle, 500Hz with 10 – 80% duty cycle, and 1000Hz with 10 – 70% duty cycle. Figures 2 & 3 show the output response at the maximum PWM DIM signal of 1000Hz. See figure 4 for 100Hz to 1000Hz duty cycle response for two Luxeon K2 LEDs in parallel at 2A total current.

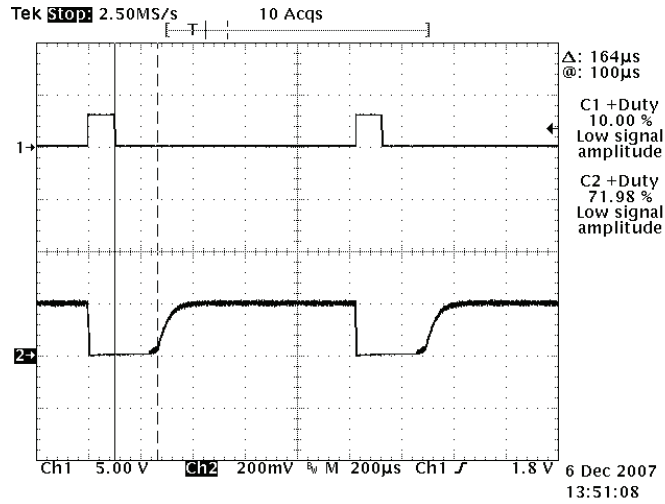

**Figure 2. 1KHz, 10% duty cycle dimming signal is approximately 70% LED duty Cycle
Ch1 = DIM signal, Ch2 = VFB 200mV/div = 2A Output current/div**

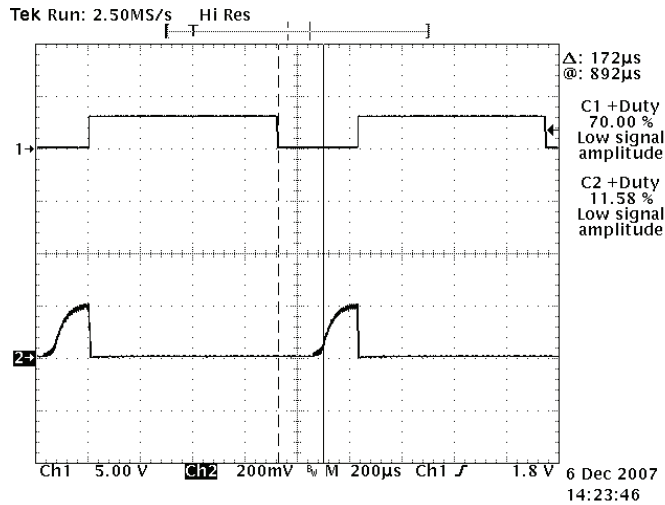

**Figure 3. 1KHz, 70% duty cycle dimming signal is approximately 10% LED duty cycle
Ch1 = DIM signal, Ch2 = VFB 200mV/div = 2A Output current/div**

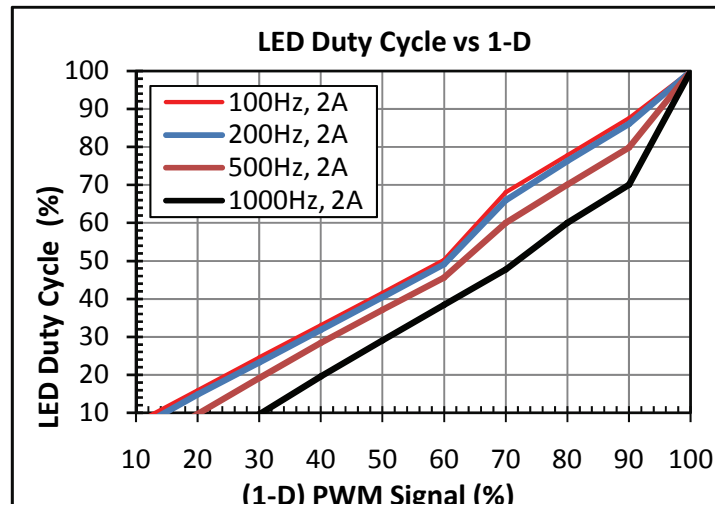

Figure 4. LED Duty Cycle Vs (1-D) DIM pin Duty Cycle with 12Vin, 2 Luxeon K2s in parallel at 2A total

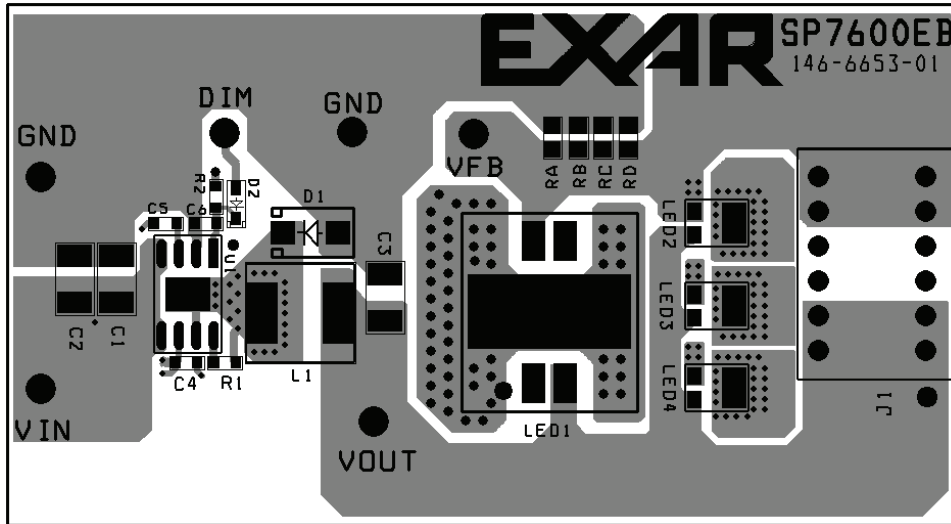

Figure 5. SP7600 Evaluation Board Layout top

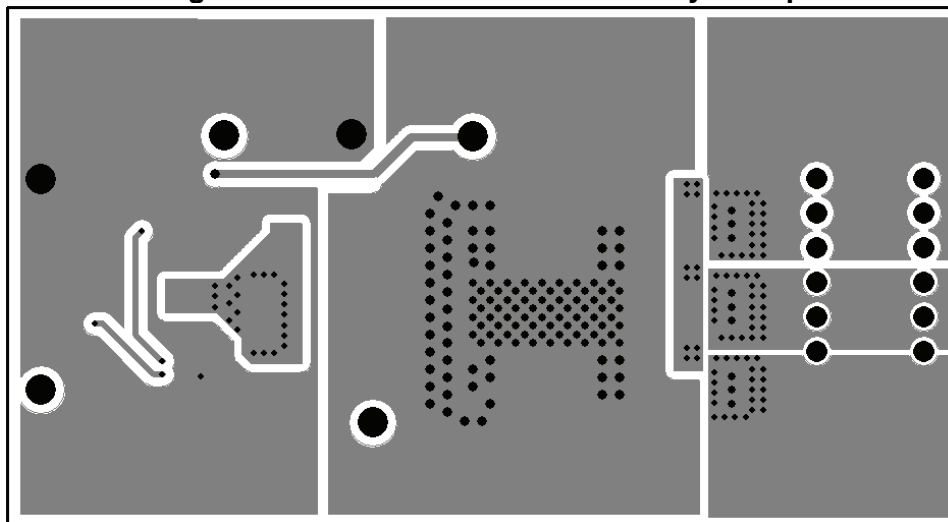

Figure 6. SP7600 Evaluation Board Layout bottom

BILL OF MATERIALS

Line No.	Ref. Des.	Qty.	Manuf.	Manuf. Part Number	Layout Size	Component	Vendor Phone Number
1	PCB	1	Exar	146-6653-01	1.175"x1.934"	SP7600EB	408-934-7500
2	U1	1	Exar	SP7600	SO-8 EP	Non-Sync. LED Driver	408-934-7500
3	LED1	1	LUXEON	LXK2-PW12-R00	K2	LUXEON K2	662-536-0401
4	DS	1	On Semi	MBRA340T3	SMA	Schottky, 40V, 3A	602-244-6600
5	L1	1	WURTH	744311470	7.0X6.9mm	4.7uH inductor WE-HC	201-785-8800
6	D1	1	MCC	1N4148WX	SOD323	Fast Switching Diode 500mW	818-701-4933
7	C1	1	Taiyo Yuden	UMK325BJ106MM-T	1210	10uF Ceramic, 50V, X7S, 1210	800-388-2496
8	C6					open	
9	C4, C5	1	MURATA	GRM188R71H104K	0603	0.1uF Ceramic, X7R, 50V	770-436-1300
10	R1	1	VISHAY/DALE	CRCW06030000Z	0603	0 Ohm	402-563-6866
11	R2	1	VISHAY/DALE	CRCW0603100KF	0603	100k Ohm	402-563-6866
12	Ra	1	SUSUMU CO. LTD	RL1220S-R22-F	0805	0.22 Ohm	402-563-6866
13	LINK	1	TYCO ELECTR.	535676-5		CONN. RECEPT 6POS .100 RT/ANG	800-344-4539
14	VIN, VOUT, GND, GND, DIM, VFB	6	Vector Electronic	K24C/M	.042 Dia	Test Point Post	800-344-4539

Table1. SP7600EB List of Materials

ORDERING INFORMATION

Model	Temperature Range	Package Type
SP7600EB.....	-40°C to +85°C.....	SP7600 Evaluation Board

For further assistance:

Email: customersupport@exar.com
 EXAR Technical Documentation: <http://www.exar.com/TechDoc/default.aspx?>



Exar Corporation
Headquarters and
Sales Office
 48720 Kato Road
 Fremont, CA 94538
 main: 510-668-7000
 fax: 510-668-7000

EXAR Corporation reserves the right to make changes to the products contained in this publication in order to improve design, performance or reliability. EXAR Corporation assumes no responsibility for the use of any circuits described herein, conveys no license under any patent or other right, and makes no representation that the circuits are free of patent infringement. Charts and schedules contained herein are only for illustration purposes and may vary depending upon a user's specific application. While the information in this publication has been carefully checked; no responsibility, however, is assumed for inaccuracies.

EXAR Corporation does not recommend the use of any of its products in life support applications where the failure or malfunction of the product can reasonably be expected to cause failure of the life support system or to significantly affect its safety or effectiveness. Products are not authorized for use in such applications unless EXAR Corporation receives, in writing, assurances to its satisfaction that: (a) the risk of injury or damage has been minimized; (b) the user assumes all such risks; (c) potential liability of EXAR Corporation is adequately protected under the circumstances.