

**ebm-papst St. Georgen GmbH & Co. KG**

Hermann-Papst-Str. 1
 D-78112 St. Georgen
 Phone +49 (0) 7724 81-0
 Fax +49 (0) 7724 81-1309
 info2@de.ebmpapst.com
 www.ebmpapst.com

Nominal data

Type	4314 NH3	
Nominal voltage	VDC	24
Nominal voltage range	VDC	14 .. 26,4
Speed (rpm)	min ⁻¹	4050
Power consumption	W	11
Min. ambient temperature	°C	-20
Max. ambient temperature	°C	70
Air flow	m ³ /h	285
Sound power level	B	6.6
Sound pressure level	dB(A)	55

ml = Max. load · me = Max. efficiency · fa = Free air · cs = Customer specification · ce = Customer equipment
 Subject to change

Technical description

Weight	0.25 kg
Dimensions	119 x 119 x 32 mm
Impeller material	Glass-fiber reinforced PA plastic
Housing material	Glass-fiber reinforced PBT plastic
Part no.	9293510712
Airflow direction	Exhaust over struts
Direction of rotation	Clockwise, viewed toward rotor
Bearing	Ball bearing
Service life L10 at 40 °C	45.000 h
Service life L10 at maximum temperature	17.500 h
Cable	With leads AWG 24, TR 64



Product drawing

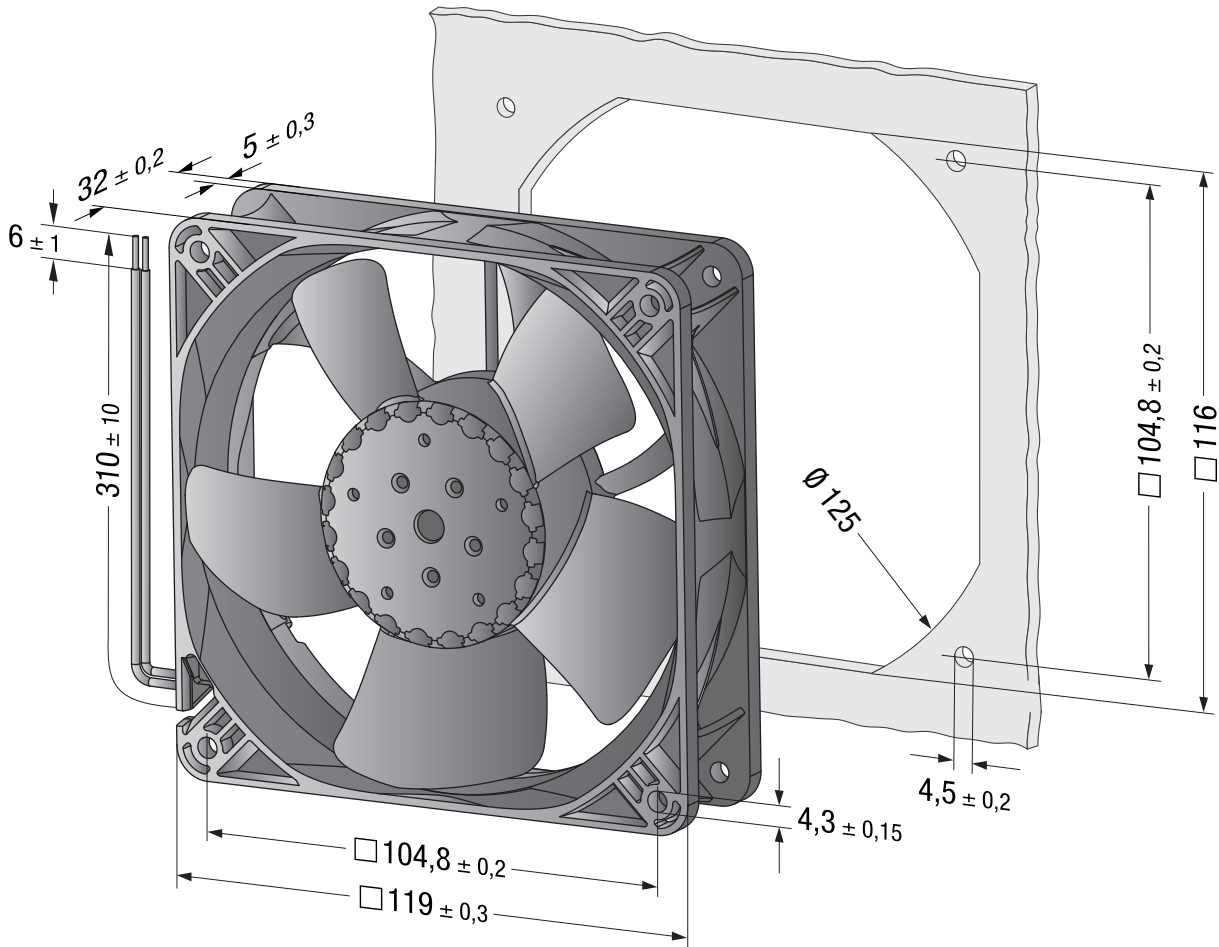

Curves

