





Grayhill, Inc.

62S11-N5-060SH

Part Number:	62S11-N5-060SH
Manufacturer/Brand:	Grayhill, Inc.
Product description:	ROTARY ENCODER OPTICAL 32PPR
Datasheets:	 62S11-N5-060SH.pdf
RoHS Status:	 Lead free / RoHS Compliant
Stock Condition:	2263 pcs stock
Ship From:	Hong Kong
Shipment Way:	DHL/Fedex/TNT/UPS/EMS



[REQUEST FOR QUOTATION](#)

Image may be representation. See specifications for product details.



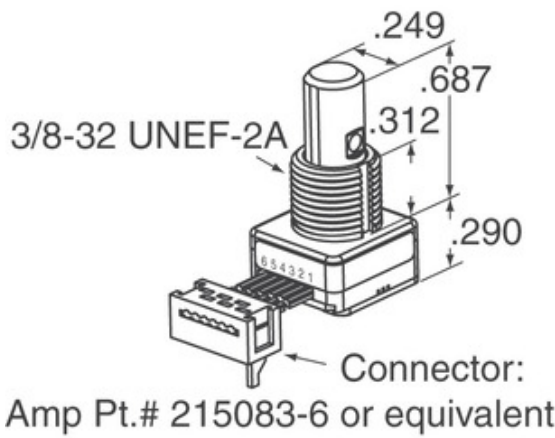

Specifications of 62S11-N5-060SH

PART NUMBER	62S11-N5-060SH
MANUFACTURER	Grayhill, Inc.
DESCRIPTION	ROTARY ENCODER OPTICAL 32PPR
LEAD FREE STATUS / ROHS STATUS	Lead free / RoHS Compliant
QUANTITY AVAILABLE	2263 pcs
DATA SHEET	 62S11-N5-060SH.pdf
VOLTAGE - SUPPLY	5V
TERMINATION STYLE	Cable Leads
SERIES	62S
ROTATIONAL LIFE (CYCLES MIN)	1M
PULSES PER REVOLUTION	32
OUTPUT TYPE	Quadrature (Incremental)
OTHER NAMES	62S11N5060SH
ORIENTATION	Vertical
MOUNTING TYPE	Panel Mount
MOISTURE SENSITIVITY LEVEL (MSL)	1 (Unlimited)
LEAD FREE STATUS / ROHS STATUS	Lead free / RoHS Compliant
ENCODER TYPE	Optical
DETENT	No
BUILT IN SWITCH	Yes
ACTUATOR TYPE	1/4" Dia Flatted End

Related Tags

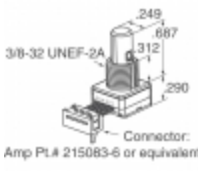
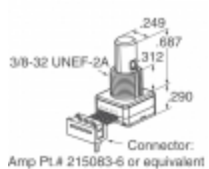
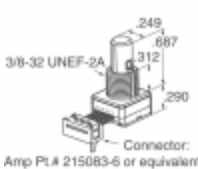
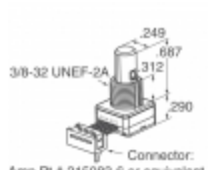
Grayhill, Inc. 62S11-N5-060SH	62S11-N5-060SH Distributor	62S11-N5-060SH Supplier
62S11-N5-060SH Price	62S11-N5-060SH Pictures	62S11-N5-060SH Image
62S11-N5-060SH PDF Datasheet	62S11-N5-060SH Download Datasheet	62S11-N5-060SH Datasheet
62S11-N5-060SH Stock	Buy 62S11-N5-060SH	Buy Grayhill, Inc. 62S11-N5-060SH
Grayhill, Inc. 62S11-N5-060SH	Grayhill, Inc. Supplier	Grayhill, Inc. Distributor
Grayhill, Inc. 62S11-N5-060SH	Grayhill Inc. 62S11-N5-060SH	

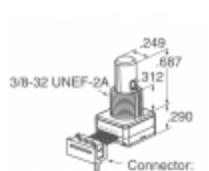
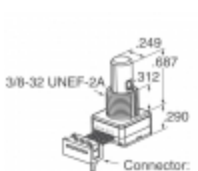
Related Products

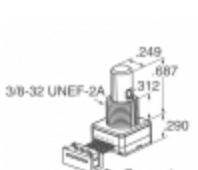
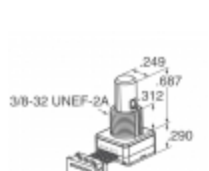
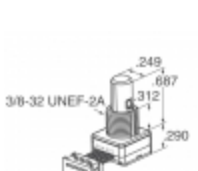
 <p>62S11-N5-025C Manufacturers: Grayhill, Inc. Description: ROTARY ENCODER OPTICAL 32PPR In stock: 2408 pcs</p> <p>RFQ</p>	 <p>62S11-N5-P Manufacturers: Grayhill, Inc. Description: ROTARY ENCODER OPTICAL 32PPR In stock: 1885 pcs</p> <p>RFQ</p>
 <p>62S11-N5-120S Manufacturers: Grayhill, Inc. Description: ROTARY ENCODER OPTICAL 32PPR In stock: 1675 pcs</p> <p>RFQ</p>	 <p>62S11-N5-060C Manufacturers: Grayhill, Inc. Description: ROTARY ENCODER OPTICAL 32PPR In stock: 2164 pcs</p> <p>RFQ</p>
 <p>62S11-N5-040C Manufacturers: Grayhill, Inc. Description: ROTARY ENCODER OPTICAL 32PPR In stock: 2106 pcs</p> <p>RFQ</p>	 <p>62S11-N5-PV Manufacturers: Grayhill, Inc. Description: ROTARY ENCODER OPTICAL 32PPR In stock: 2220 pcs</p> <p>RFQ</p>
 <p>62S11-N5-050C Manufacturers: Grayhill, Inc. Description: ROTARY ENCODER OPTICAL 32PPR In stock: 1936 pcs</p> <p>RFQ</p>	 <p>62S11-N5-080SH Manufacturers: Grayhill, Inc. Description: ROTARY ENCODER OPTICAL 32PPR In stock: 1942 pcs</p> <p>RFQ</p>
 <p>62S11-N5-025CH Manufacturers: Grayhill, Inc. Description: ROTARY ENCODER OPTICAL 32PPR In stock: 2083 pcs</p> <p>RFQ</p>	 <p>62S11-N4-PH Manufacturers: Grayhill, Inc. Description: ROTARY ENCODER OPTICAL 32PPR In stock: 1970 pcs</p> <p>RFQ</p>
 <p>62S11-N5-100C Manufacturers: Grayhill, Inc. Description: ROTARY ENCODER OPTICAL 32PPR In stock: 1789 pcs</p> <p>RFQ</p>	 <p>62S11-N9-060C Manufacturers: Grayhill, Inc. Description: ROTARY ENCODER OPTICAL 32PPR In stock: 2192 pcs</p> <p>RFQ</p>

Copyright © 2020 Reliable Distributor of Electronic Components

E-mail: Info@infinity-electronic.com

Address: 17F, Gaylord Commercial Building, 114-118 Lockhart Road, Wan Chai, Hong Kong

