





Grayhill, Inc.

62S11-M9-030S

Part Number:	62S11-M9-030S
Manufacturer/Brand:	Grayhill, Inc.
Product description:	ROTARY ENCODER OPTICAL 32PPR
Datasheets:	 62S11-M9-030S.pdf
RoHS Status:	 Lead free / RoHS Compliant
Stock Condition:	1918 pcs stock
Ship From:	Hong Kong
Shipment Way:	DHL/Fedex/TNT/UPS/EMS



[REQUEST FOR QUOTATION](#)

Image may be representation. See specifications for product details.



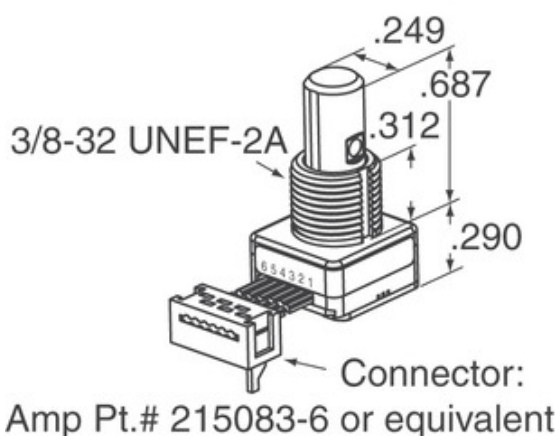

Specifications of 62S11-M9-030S

PART NUMBER	62S11-M9-030S
MANUFACTURER	Grayhill, Inc.
DESCRIPTION	ROTARY ENCODER OPTICAL 32PPR
LEAD FREE STATUS / ROHS STATUS	Lead free / RoHS Compliant
QUANTITY AVAILABLE	1918 pcs
DATA SHEET	 62S11-M9-030S.pdf
VOLTAGE - SUPPLY	5V
TERMINATION STYLE	Cable Leads
SERIES	62S
ROTATIONAL LIFE (CYCLES MIN)	1M
PULSES PER REVOLUTION	32
OUTPUT TYPE	Quadrature (Incremental)
OTHER NAMES	62S11M9030S
ORIENTATION	Vertical
MOUNTING TYPE	Panel Mount
MOISTURE SENSITIVITY LEVEL (MSL)	1 (Unlimited)
LEAD FREE STATUS / ROHS STATUS	Lead free / RoHS Compliant
ENCODER TYPE	Optical
DETENT	Yes
BUILT IN SWITCH	Yes
ACTUATOR TYPE	1/4" Dia Flatted End

Related Tags

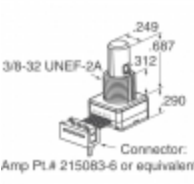
Grayhill, Inc. 62S11-M9-030S	62S11-M9-030S Distributor	62S11-M9-030S Supplier
62S11-M9-030S Price	62S11-M9-030S Pictures	62S11-M9-030S Image
62S11-M9-030S PDF Datasheet	62S11-M9-030S Download Datasheet	62S11-M9-030S Datasheet
62S11-M9-030S Stock	Buy 62S11-M9-030S	Buy Grayhill, Inc. 62S11-M9-030S
Grayhill, Inc. 62S11-M9-030S	Grayhill, Inc. Supplier	Grayhill, Inc. Distributor
Grayhill, Inc. 62S11-M9-030S	Grayhill Inc. 62S11-M9-030S	

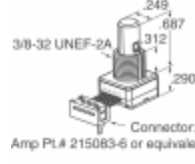
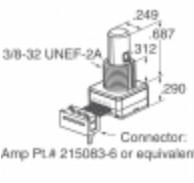
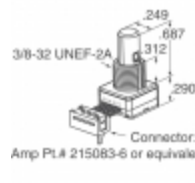
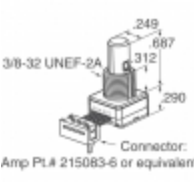
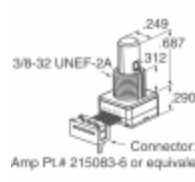
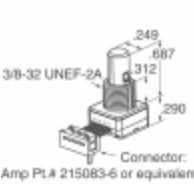
Related Products

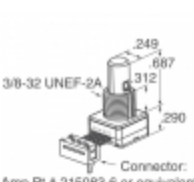
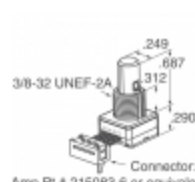
 <p>62S11-M9-020C Manufacturers: Grayhill, Inc. Description: ROTARY ENCODER OPTICAL 32PPR In stock: 2241 pcs</p> <p>RFQ</p>	 <p>62S11-M5-PH Manufacturers: Grayhill, Inc. Description: ROTARY ENCODER OPTICAL 32PPR In stock: 2451 pcs</p> <p>RFQ</p>
 <p>62S11-M5-P Manufacturers: Grayhill, Inc. Description: ROTARY ENCODER OPTICAL 32PPR In stock: 2458 pcs</p> <p>RFQ</p>	 <p>62S11-M9-095CH Manufacturers: Grayhill, Inc. Description: ROTARY ENCODER OPTICAL 32PPR In stock: 1978 pcs</p> <p>RFQ</p>
 <p>62S11-M9-040SH Manufacturers: Grayhill, Inc. Description: ROTARY ENCODER OPT 32PPR 4" CBL In stock: 1879 pcs</p> <p>RFQ</p>	 <p>62S11-M9-040C Manufacturers: Grayhill, Inc. Description: ROTARY ENCODER OPTICAL 32PPR In stock: 1933 pcs</p> <p>RFQ</p>
 <p>62S11-M9-050C Manufacturers: Grayhill, Inc. Description: ROTARY ENCODER OPTICAL 32PPR In stock: 2082 pcs</p> <p>RFQ</p>	 <p>62S11-M9-100C Manufacturers: Grayhill, Inc. Description: ROTARY ENCODER OPTICAL 32PPR In stock: 2260 pcs</p> <p>RFQ</p>
 <p>62S11-M9-020S Manufacturers: Grayhill, Inc. Description: ROTARY ENCODER OPTICAL 32PPR In stock: 2269 pcs</p> <p>RFQ</p>	 <p>62S11-M9-020CH Manufacturers: Grayhill, Inc. Description: ROTARY ENCODER OPTICAL 32PPR In stock: 2097 pcs</p> <p>RFQ</p>
 <p>62S11-M9-060C Manufacturers: Grayhill, Inc. Description: ROTARY ENCODER OPTICAL 32PPR In stock: 2060 pcs</p> <p>RFQ</p>	 <p>62S11-M9-025S Manufacturers: Grayhill, Inc. Description: ROTARY ENCODER OPTICAL 32PPR In stock: 2070 pcs</p> <p>RFQ</p>

Copyright © 2020 Reliable Distributor of Electronic Components

E-mail: Info@infinity-electronic.com

Address: 17F, Gaylord Commercial Building, 114-118 Lockhart Road, Wan Chai, Hong Kong

