





Grayhill, Inc.

**62S11-N5-060C**

Part Number:	62S11-N5-060C
Manufacturer/Brand:	Grayhill, Inc.
Product description:	ROTARY ENCODER OPTICAL 32PPR
Datasheets:	 <a href="#">62S11-N5-060C.pdf</a>
RoHS Status:	 Lead free / RoHS Compliant
Stock Condition:	2164 pcs stock
Ship From:	Hong Kong
Shipment Way:	DHL/Fedex/TNT/UPS/EMS



[REQUEST FOR QUOTATION](#)

Image may be representation. See specifications for product details.



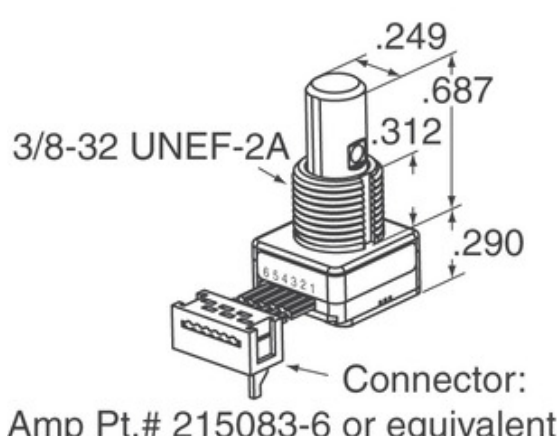

## Specifications of 62S11-N5-060C

PART NUMBER	62S11-N5-060C
MANUFACTURER	Grayhill, Inc.
DESCRIPTION	ROTARY ENCODER OPTICAL 32PPR
LEAD FREE STATUS / ROHS STATUS	Lead free / RoHS Compliant
QUANTITY AVAILABLE	2164 pcs
DATA SHEET	 <a href="#">62S11-N5-060C.pdf</a>
VOLTAGE - SUPPLY	5V
TERMINATION STYLE	Cable with Connector
SERIES	62S
ROTATIONAL LIFE (CYCLES MIN)	1M
PULSES PER REVOLUTION	32
OUTPUT TYPE	Quadrature (Incremental)
OTHER NAMES	62S11N5060C
ORIENTATION	Vertical
MOUNTING TYPE	Panel Mount
MOISTURE SENSITIVITY LEVEL (MSL)	1 (Unlimited)
LEAD FREE STATUS / ROHS STATUS	Lead free / RoHS Compliant
ENCODER TYPE	Optical
DETENT	No
BUILT IN SWITCH	Yes
ACTUATOR TYPE	1/4" Dia Flatted End

## Related Tags

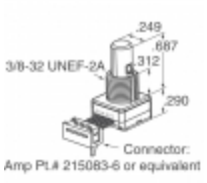
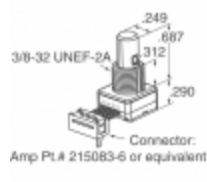
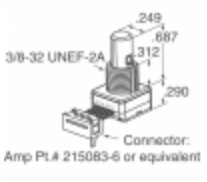
Grayhill, Inc. 62S11-N5-060C	62S11-N5-060C Distributor	62S11-N5-060C Supplier
62S11-N5-060C Price	62S11-N5-060C Pictures	62S11-N5-060C Image
62S11-N5-060C PDF Datasheet	62S11-N5-060C Download Datasheet	62S11-N5-060C Datasheet
62S11-N5-060C Stock	Buy 62S11-N5-060C	Buy Grayhill, Inc. 62S11-N5-060C
Grayhill, Inc. 62S11-N5-060C	Grayhill, Inc. Supplier	Grayhill, Inc. Distributor
Grayhill, Inc. 62S11-N5-060C	Grayhill Inc. 62S11-N5-060C	

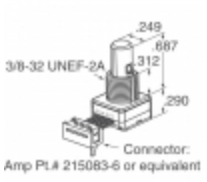
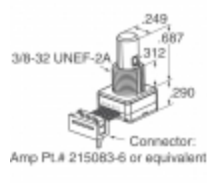
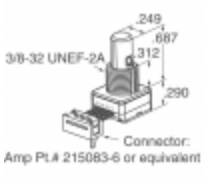
## Related Products

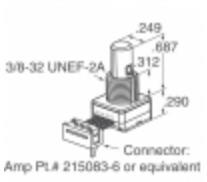
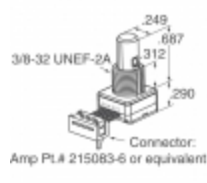
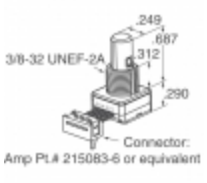
 <p><b>62S11-N5-025CH</b> Manufacturers: Grayhill, Inc. Description: ROTARY ENCODER OPTICAL 32PPR In stock: 2083 pcs</p> <p><a href="#">RFQ</a></p>	 <p><b>62S11-N5-P</b> Manufacturers: Grayhill, Inc. Description: ROTARY ENCODER OPTICAL 32PPR In stock: 1885 pcs</p> <p><a href="#">RFQ</a></p>
 <p><b>62S11-N5-040C</b> Manufacturers: Grayhill, Inc. Description: ROTARY ENCODER OPTICAL 32PPR In stock: 2106 pcs</p> <p><a href="#">RFQ</a></p>	 <p><b>62S11-N5-050C</b> Manufacturers: Grayhill, Inc. Description: ROTARY ENCODER OPTICAL 32PPR In stock: 1936 pcs</p> <p><a href="#">RFQ</a></p>
 <p><b>62S11-N5-PV</b> Manufacturers: Grayhill, Inc. Description: ROTARY ENCODER OPTICAL 32PPR In stock: 2220 pcs</p> <p><a href="#">RFQ</a></p>	 <p><b>62S11-N5-120S</b> Manufacturers: Grayhill, Inc. Description: ROTARY ENCODER OPTICAL 32PPR In stock: 1675 pcs</p> <p><a href="#">RFQ</a></p>
 <p><b>62S11-N5-080SH</b> Manufacturers: Grayhill, Inc. Description: ROTARY ENCODER OPTICAL 32PPR In stock: 1942 pcs</p> <p><a href="#">RFQ</a></p>	 <p><b>62S11-N4-PH</b> Manufacturers: Grayhill, Inc. Description: ROTARY ENCODER OPTICAL 32PPR In stock: 1970 pcs</p> <p><a href="#">RFQ</a></p>
 <p><b>62S11-N5-025C</b> Manufacturers: Grayhill, Inc. Description: ROTARY ENCODER OPTICAL 32PPR In stock: 2408 pcs</p> <p><a href="#">RFQ</a></p>	 <p><b>62S11-N4-P</b> Manufacturers: Grayhill, Inc. Description: ROTARY ENCODER OPTICAL 32PPR In stock: 1912 pcs</p> <p><a href="#">RFQ</a></p>
 <p><b>62S11-N5-100C</b> Manufacturers: Grayhill, Inc. Description: ROTARY ENCODER OPTICAL 32PPR In stock: 1789 pcs</p> <p><a href="#">RFQ</a></p>	 <p><b>62S11-N5-060SH</b> Manufacturers: Grayhill, Inc. Description: ROTARY ENCODER OPTICAL 32PPR In stock: 2263 pcs</p> <p><a href="#">RFQ</a></p>

Copyright © 2020 Reliable Distributor of Electronic Components

E-mail: [Info@infinity-electronic.com](mailto:Info@infinity-electronic.com)

Address: 17F, Gaylord Commercial Building, 114-118 Lockhart Road, Wan Chai, Hong Kong

