





Grayhill, Inc.

62S11-N4-060SH

| | |
|----------------------|--|
| Part Number: | 62S11-N4-060SH |
| Manufacturer/Brand: | Grayhill, Inc. |
| Product description: | ROTARY ENCODER OPTICAL 32PPR |
| Datasheets: |  62S11-N4-060SH.pdf |
| RoHS Status: |  Lead free / RoHS Compliant |
| Stock Condition: | 2262 pcs stock |
| Ship From: | Hong Kong |
| Shipment Way: | DHL/Fedex/TNT/UPS/EMS |



[REQUEST FOR QUOTATION](#)

Image may be representation. See specifications for product details.





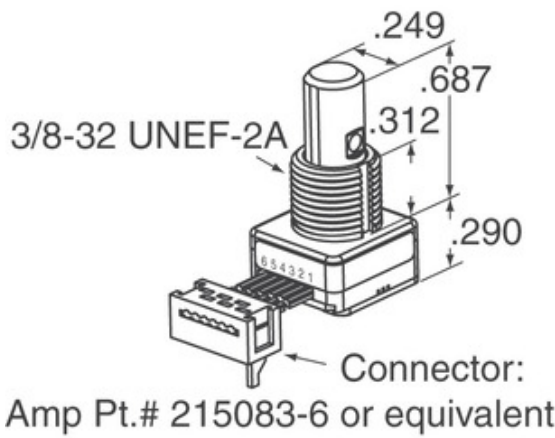

Specifications of 62S11-N4-060SH

| | |
|----------------------------------|--|
| PART NUMBER | 62S11-N4-060SH |
| MANUFACTURER | Grayhill, Inc. |
| DESCRIPTION | ROTARY ENCODER OPTICAL 32PPR |
| LEAD FREE STATUS / ROHS STATUS | Lead free / RoHS Compliant |
| QUANTITY AVAILABLE | 2262 pcs |
| DATA SHEET |  62S11-N4-060SH.pdf |
| VOLTAGE - SUPPLY | 5V |
| TERMINATION STYLE | Cable Leads |
| SERIES | 62S |
| ROTATIONAL LIFE (CYCLES MIN) | 1M |
| PULSES PER REVOLUTION | 32 |
| OUTPUT TYPE | Quadrature (Incremental) |
| OTHER NAMES | 62S11N4060SH |
| ORIENTATION | Vertical |
| MOUNTING TYPE | Panel Mount |
| MOISTURE SENSITIVITY LEVEL (MSL) | 1 (Unlimited) |
| LEAD FREE STATUS / ROHS STATUS | Lead free / RoHS Compliant |
| ENCODER TYPE | Optical |
| DETENT | No |
| BUILT IN SWITCH | Yes |
| ACTUATOR TYPE | 1/4" Dia Flatted End |

Related Tags

| | | |
|-------------------------------|-----------------------------------|-----------------------------------|
| Grayhill, Inc. 62S11-N4-060SH | 62S11-N4-060SH Distributor | 62S11-N4-060SH Supplier |
| 62S11-N4-060SH Price | 62S11-N4-060SH Pictures | 62S11-N4-060SH Image |
| 62S11-N4-060SH PDF Datasheet | 62S11-N4-060SH Download Datasheet | 62S11-N4-060SH Datasheet |
| 62S11-N4-060SH Stock | Buy 62S11-N4-060SH | Buy Grayhill, Inc. 62S11-N4-060SH |
| Grayhill, Inc. 62S11-N4-060SH | Grayhill, Inc. Supplier | Grayhill, Inc. Distributor |
| Grayhill, Inc. 62S11-N4-060SH | Grayhill Inc. 62S11-N4-060SH | |

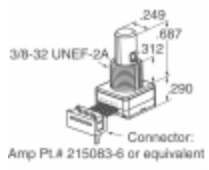
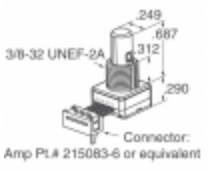
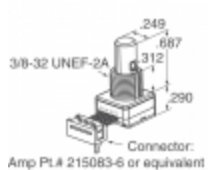
Related Products

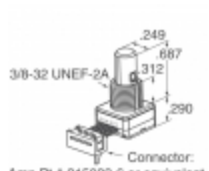
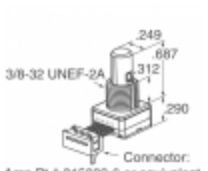
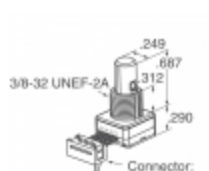
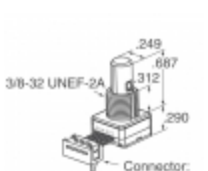
| | |
|---|--|
|  <p>62S11-N4-025C Manufacturers: Grayhill, Inc. Description: ROTARY ENCODER OPTICAL 32PPR In stock: 1970 pcs</p> <p>RFQ</p> |  <p>62S11-N5-025CH Manufacturers: Grayhill, Inc. Description: ROTARY ENCODER OPTICAL 32PPR In stock: 2083 pcs</p> <p>RFQ</p> |
|  <p>62S11-N5-040C Manufacturers: Grayhill, Inc. Description: ROTARY ENCODER OPTICAL 32PPR In stock: 2106 pcs</p> <p>RFQ</p> |  <p>62S11-N5-025C Manufacturers: Grayhill, Inc. Description: ROTARY ENCODER OPTICAL 32PPR In stock: 2408 pcs</p> <p>RFQ</p> |
|  <p>62S11-N4-P Manufacturers: Grayhill, Inc. Description: ROTARY ENCODER OPTICAL 32PPR In stock: 1912 pcs</p> <p>RFQ</p> |  <p>62S11-N4-120S Manufacturers: Grayhill, Inc. Description: ROTARY ENCODER OPTICAL 32PPR In stock: 2038 pcs</p> <p>RFQ</p> |
|  <p>62S11-N4-PH Manufacturers: Grayhill, Inc. Description: ROTARY ENCODER OPTICAL 32PPR In stock: 1970 pcs</p> <p>RFQ</p> |  <p>62S11-N4-020C Manufacturers: Grayhill, Inc. Description: ROTARY ENCODER OPTICAL 32PPR In stock: 2083 pcs</p> <p>RFQ</p> |
|  <p>62S11-N4-025CH Manufacturers: Grayhill, Inc. Description: ROTARY ENCODER OPTICAL 32PPR In stock: 1946 pcs</p> <p>RFQ</p> |  <p>62S11-N2-PH Manufacturers: Grayhill, Inc. Description: ROTARY ENCODER OPTICAL 32PPR In stock: 1760 pcs</p> <p>RFQ</p> |
|  <p>62S11-N3-PH Manufacturers: Grayhill, Inc. Description: ROTARY ENCODER OPTICAL 32PPR In stock: 1856 pcs</p> <p>RFQ</p> |  <p>62S11-N2-P Manufacturers: Grayhill, Inc. Description: ROTARY ENCODER OPTICAL 32PPR In stock: 2376 pcs</p> <p>RFQ</p> |

Copyright © 2020 Reliable Distributor of Electronic Components

E-mail: Info@infinity-electronic.com

Address: 17F, Gaylord Commercial Building, 114-118 Lockhart Road, Wan Chai, Hong Kong

