

Honeywell

Honeywell Sensing and Productivity Solutions

MLH025BSG17B

Part Number:	MLH025BSG17B
Manufacturer/Brand:	Honeywell Sensing and Productivity Solutions
Product description:	MLH ALL METAL PRESS SENSE -ATF
Datasheets:	1.MLH025BSG17B.pdf 2.MLH025BSG17B.pdf
RoHs Status:	 Lead free / RoHS Compliant
Stock Condition:	5935 pcs stock
Ship From:	Hong Kong
Shipment Way:	DHL/Fedex/TNT/UPS/EMS

[REQUEST FOR QUOTATION](#)

Productivity Solutions

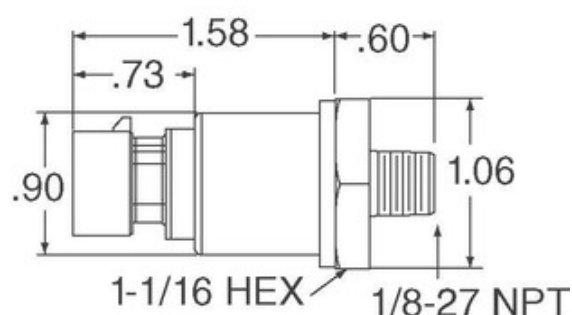

Image may be representation. See specifications for product details.



Specifications of MLH025BSG17B

PART NUMBER	MLH025BSG17B
MANUFACTURER	Honeywell Sensing and Productivity Solutions
DESCRIPTION	MLH ALL METAL PRESS SENSE -ATF
LEAD FREE STATUS / ROHS STATUS	Lead free / RoHS Compliant
QUANTITY AVAILABLE	5935 pcs
DATA SHEET	1.MLH025BSG17B.pdf 2.MLH025BSG17B.pdf
VOLTAGE - SUPPLY	9.5 V ~ 30 V
SUPPLIER DEVICE PACKAGE	-
SERIES	MLH
PRESSURE TYPE	Sealed Gauge
PORT STYLE	Threaded
PORT SIZE	Male - 1/4" (6.35mm) BSP
PACKAGE / CASE	Cylinder, Metal
OUTPUT TYPE	Analog Current
OUTPUT	4 mA ~ 20 mA
OPERATING TEMPERATURE	-40°C ~ 125°C
OPERATING PRESSURE	362.59 PSI (2500 kPa)
MOISTURE SENSITIVITY LEVEL (MSL)	1 (Unlimited)
MAXIMUM PRESSURE	1087.78 PSI (7500 kPa)
LEAD FREE STATUS / ROHS STATUS	Lead free / RoHS Compliant
FEATURES	Amplified Output, Temperature Compensated
DETAILED DESCRIPTION	Pressure Sensor 362.59 PSI (2500 kPa) Sealed Gauge Male - 1/4" (6.35mm) BSP 4 mA ~ 20 mA Cylinder, Metal
ACCURACY	±0.25%

Related Tags

Honeywell Sensing and Productivity Solutions MLH025BSG17B	MLH025BSG17B Distributor	MLH025BSG17B Supplier
MLH025BSG17B Price	MLH025BSG17B Pictures	MLH025BSG17B Image
MLH025BSG17B PDF Datasheet	MLH025BSG17B Download Datasheet	MLH025BSG17B Datasheet
MLH025BSG17B Stock	Buy MLH025BSG17B	Buy Honeywell Sensing and Productivity Solutions MLH025BSG17B
Honeywell Sensing and Productivity Solutions MLH025BSG17B	Honeywell Sensing and Productivity Solutions Supplier	Honeywell Sensing and Productivity Solutions Distributor
Honeywell Sensing and Productivity Solutions MLH025BSG17B	HONEYWELL MLH025BSG17B	Honeywell Sensing and Control EMEA MLH025BSG17B
Honeywell Sensing and Productivity Solutions T&M MLH025BSG17B		

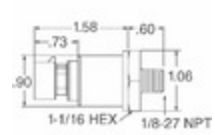
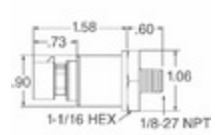
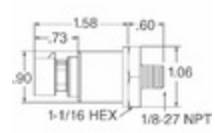
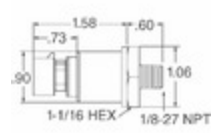
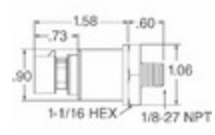
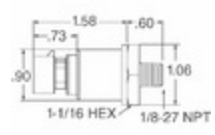
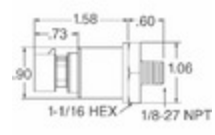
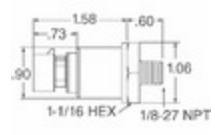
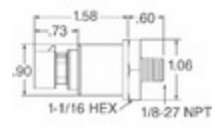
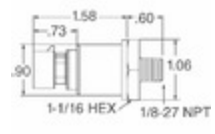
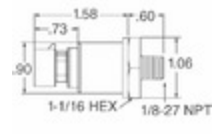
Related Products

 <p>MLH025BSD14E Manufacturers: Honeywell Sensing and Productivity Solutions Description: SENSOR SEALED GAUGE 0-25 BAR In stock: 3961 pcs</p> <p>RFQ</p>	 <p>MLH025BGG20B Manufacturers: Honeywell Sensing and Productivity Solutions Description: MLH ALL METAL PRESS SENSE -ATF In stock: 5780 pcs</p> <p>RFQ</p>
 <p>MLH025BSD14A Manufacturers: Honeywell Sensing and Productivity Solutions Description: SENSOR SEALED GAUGE 0-25 BAR In stock: 3422 pcs</p> <p>RFQ</p>	 <p>MLH025BSD14B Manufacturers: Honeywell Sensing and Productivity Solutions Description: SENSOR SEALED GAUGE 0-25 BAR In stock: 931 pcs</p> <p>RFQ</p>
 <p>MLH02KPSG06A Manufacturers: Honeywell Sensing and Productivity Solutions Description: MLH ALL METAL PRESS SENSE -ATF In stock: 1138 pcs</p> <p>RFQ</p>	 <p>MLH02KPSB01A Manufacturers: Honeywell Sensing and Productivity Solutions Description: MLH ALL METAL PRESS SENSE -ATF In stock: 6335 pcs</p> <p>RFQ</p>
 <p>MLH025BSG01B Manufacturers: Honeywell Sensing and Productivity Solutions Description: SENSOR SEALED GAUGE 0-25 BAR In stock: 953 pcs</p> <p>RFQ</p>	 <p>MLH02KPSB10A Manufacturers: Honeywell Sensing and Productivity Solutions Description: MLH ALL METAL PRESS SENSE -ATF In stock: 1023 pcs</p> <p>RFQ</p>
 <p>MLH02KPSB01D Manufacturers: Honeywell Sensing and Productivity Solutions Description: SENSOR SEALED GAUGE 0-2000 PSI In stock: 4415 pcs</p> <p>RFQ</p>	 <p>MLH02KPSD01A Manufacturers: Honeywell Sensing and Productivity Solutions Description: MLH ALL METAL PRESS SENSE -ATF In stock: 4839 pcs</p> <p>RFQ</p>
 <p>MLH025BSB01A Manufacturers: Honeywell Sensing and Productivity Solutions Description: MLH ALL METAL PRESS SENSE -ATF In stock: 5206 pcs</p> <p>RFQ</p>	 <p>MLH02KPSB06A Manufacturers: Honeywell Sensing and Productivity Solutions Description: SENSOR AMP 2000PSI .5-4.5VDC OUT In stock: 901 pcs</p> <p>RFQ</p>