





Grayhill, Inc.

62S11-N5-120S

Part Number:	62S11-N5-120S
Manufacturer/Brand:	Grayhill, Inc.
Product description:	ROTARY ENCODER OPTICAL 32PPR
Datasheets:	 62S11-N5-120S.pdf
RoHS Status:	 Lead free / RoHS Compliant
Stock Condition:	1675 pcs stock
Ship From:	Hong Kong
Shipment Way:	DHL/Fedex/TNT/UPS/EMS



[REQUEST FOR QUOTATION](#)

Image may be representation. See specifications for product details.

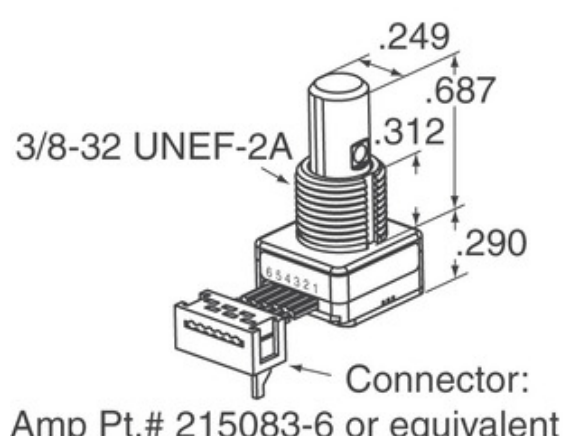

Specifications of 62S11-N5-120S

PART NUMBER	62S11-N5-120S
MANUFACTURER	Grayhill, Inc.
DESCRIPTION	ROTARY ENCODER OPTICAL 32PPR
LEAD FREE STATUS / ROHS STATUS	Lead free / RoHS Compliant
QUANTITY AVAILABLE	1675 pcs
DATA SHEET	 62S11-N5-120S.pdf
VOLTAGE - SUPPLY	5V
TERMINATION STYLE	Cable Leads
SERIES	62S
ROTATIONAL LIFE (CYCLES MIN)	1M
PULSES PER REVOLUTION	32
OUTPUT TYPE	Quadrature (Incremental)
OTHER NAMES	62S11N5120S
ORIENTATION	Vertical
MOUNTING TYPE	Panel Mount
MOISTURE SENSITIVITY LEVEL (MSL)	1 (Unlimited)
LEAD FREE STATUS / ROHS STATUS	Lead free / RoHS Compliant
ENCODER TYPE	Optical
DETENT	No
BUILT IN SWITCH	Yes
ACTUATOR TYPE	1/4" Dia Flatted End

Related Tags

Grayhill, Inc. 62S11-N5-120S	62S11-N5-120S Distributor	62S11-N5-120S Supplier
62S11-N5-120S Price	62S11-N5-120S Pictures	62S11-N5-120S Image
62S11-N5-120S PDF Datasheet	62S11-N5-120S Download Datasheet	62S11-N5-120S Datasheet
62S11-N5-120S Stock	Buy 62S11-N5-120S	Buy Grayhill, Inc. 62S11-N5-120S
Grayhill, Inc. 62S11-N5-120S	Grayhill, Inc. Supplier	Grayhill, Inc. Distributor
Grayhill, Inc. 62S11-N5-120S	Grayhill Inc. 62S11-N5-120S	

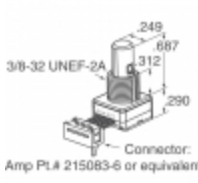
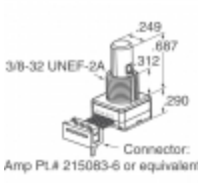
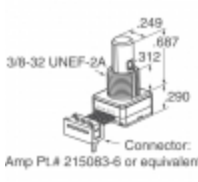
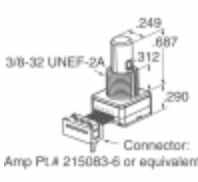
Related Products

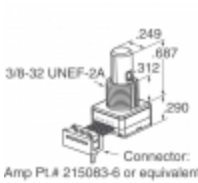
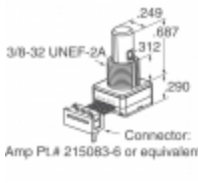
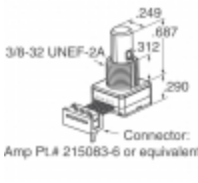
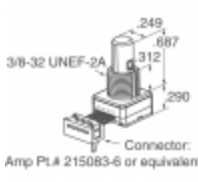
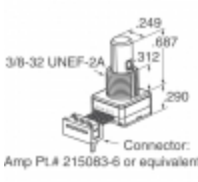
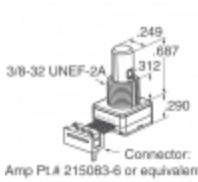
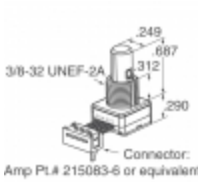
 <p>62S11-N9-060C Manufacturers: Grayhill, Inc. Description: ROTARY ENCODER OPTICAL 32PPR In stock: 2192 pcs</p> <p>RFQ</p>	 <p>62S11-N5-040C Manufacturers: Grayhill, Inc. Description: ROTARY ENCODER OPTICAL 32PPR In stock: 2106 pcs</p> <p>RFQ</p>
 <p>62S11-N9-PH Manufacturers: Grayhill, Inc. Description: ROTARY ENCODER OPTICAL 32PPR In stock: 2219 pcs</p> <p>RFQ</p>	 <p>62S11-N5-060SH Manufacturers: Grayhill, Inc. Description: ROTARY ENCODER OPTICAL 32PPR In stock: 2263 pcs</p> <p>RFQ</p>
 <p>62S11-N5-PV Manufacturers: Grayhill, Inc. Description: ROTARY ENCODER OPTICAL 32PPR In stock: 2220 pcs</p> <p>RFQ</p>	 <p>62S11-N5-P Manufacturers: Grayhill, Inc. Description: ROTARY ENCODER OPTICAL 32PPR In stock: 1885 pcs</p> <p>RFQ</p>
 <p>62S11-N5-050C Manufacturers: Grayhill, Inc. Description: ROTARY ENCODER OPTICAL 32PPR In stock: 1936 pcs</p> <p>RFQ</p>	 <p>62S11-N5-080SH Manufacturers: Grayhill, Inc. Description: ROTARY ENCODER OPTICAL 32PPR In stock: 1942 pcs</p> <p>RFQ</p>
 <p>62S11-N5-100C Manufacturers: Grayhill, Inc. Description: ROTARY ENCODER OPTICAL 32PPR In stock: 1789 pcs</p> <p>RFQ</p>	 <p>62S11-N5-060C Manufacturers: Grayhill, Inc. Description: ROTARY ENCODER OPTICAL 32PPR In stock: 2164 pcs</p> <p>RFQ</p>
 <p>62S11-N9-060SH Manufacturers: Grayhill, Inc. Description: ROTARY ENCODER OPTICAL 32PPR In stock: 1801 pcs</p> <p>RFQ</p>	 <p>62S11-N9-120S Manufacturers: Grayhill, Inc. Description: ROTARY ENCODER OPTICAL 32PPR In stock: 1784 pcs</p> <p>RFQ</p>

Copyright © 2020 Reliable Distributor of Electronic Components

E-mail: Info@infinity-electronic.com

Address: 17F, Gaylord Commercial Building, 114-118 Lockhart Road, Wan Chai, Hong Kong

