





Grayhill, Inc.

62S11-L0-055C

Part Number:	62S11-L0-055C
Manufacturer/Brand:	Grayhill, Inc.
Product description:	ROTARY ENCODER OPTICAL 32PPR
Datasheets:	 62S11-L0-055C.pdf
RoHS Status:	 Lead free / RoHS Compliant
Stock Condition:	1995 pcs stock
Ship From:	Hong Kong
Shipment Way:	DHL/Fedex/TNT/UPS/EMS



[REQUEST FOR QUOTATION](#)

Image may be representation. See specifications for product details.

Specifications of 62S11-L0-055C

PART NUMBER	62S11-L0-055C
MANUFACTURER	Grayhill, Inc.
DESCRIPTION	ROTARY ENCODER OPTICAL 32PPR
LEAD FREE STATUS / ROHS STATUS	Lead free / RoHS Compliant
QUANTITY AVAILABLE	1995 pcs
DATA SHEET	 62S11-L0-055C.pdf
VOLTAGE - SUPPLY	5V
TERMINATION STYLE	Cable with Connector
SERIES	62S
ROTATIONAL LIFE (CYCLES MIN)	1M
PULSES PER REVOLUTION	32
OUTPUT TYPE	Quadrature (Incremental)
OTHER NAMES	62S11L0055C
ORIENTATION	Vertical
MOUNTING TYPE	Panel Mount
MOISTURE SENSITIVITY LEVEL (MSL)	1 (Unlimited)
LEAD FREE STATUS / ROHS STATUS	Lead free / RoHS Compliant
ENCODER TYPE	Optical
DETENT	Yes
BUILT IN SWITCH	No
ACTUATOR TYPE	1/4" Dia Flatted End

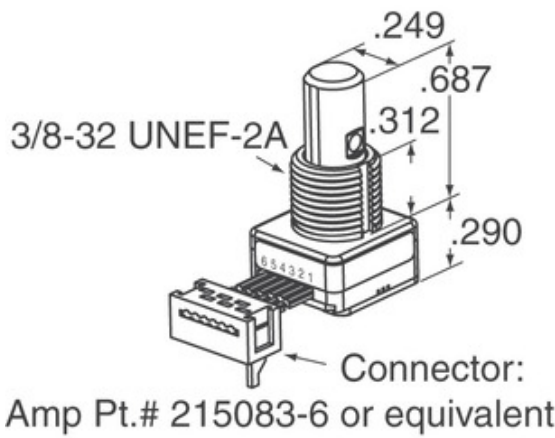
Related Tags

Grayhill, Inc. 62S11-L0-055C	62S11-L0-055C Distributor	62S11-L0-055C Supplier
62S11-L0-055C Price	62S11-L0-055C Pictures	62S11-L0-055C Image
62S11-L0-055C PDF Datasheet	62S11-L0-055C Download Datasheet	62S11-L0-055C Datasheet
62S11-L0-055C Stock	Buy 62S11-L0-055C	Buy Grayhill, Inc. 62S11-L0-055C
Grayhill, Inc. 62S11-L0-055C	Grayhill, Inc. Supplier	Grayhill, Inc. Distributor
Grayhill, Inc. 62S11-L0-055C	Grayhill Inc. 62S11-L0-055C	

Related Products

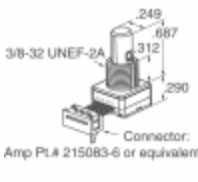
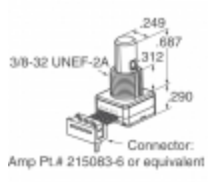
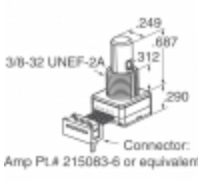
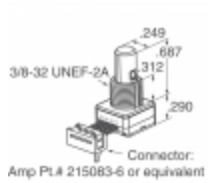
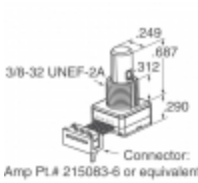
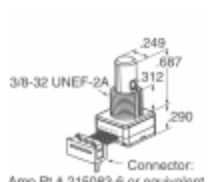
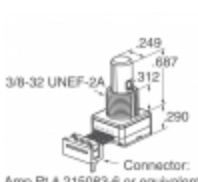
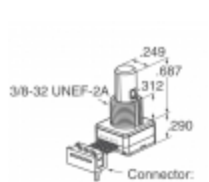
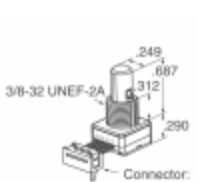
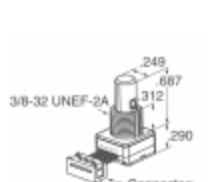
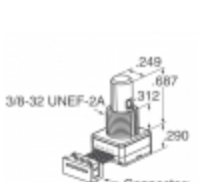
 <p>62S11-L0-040S Manufacturers: Grayhill, Inc. Description: ROTARY ENCODER OPT 32PPR 4" CBL In stock: 2058 pcs</p> <p>RFQ</p>	 <p>62S11-L0-020C Manufacturers: Grayhill, Inc. Description: ROTARY ENCODER OPTICAL 32PPR In stock: 1839 pcs</p> <p>RFQ</p>
 <p>62S11-L0-040C Manufacturers: Grayhill, Inc. Description: ROTARY ENCODER OPTICAL 32PPR In stock: 2079 pcs</p> <p>RFQ</p>	 <p>62S11-L0-PHV Manufacturers: Grayhill, Inc. Description: ROTARY ENCODER OPTICAL 32PPR In stock: 1991 pcs</p> <p>RFQ</p>
 <p>62S11-L0-PH Manufacturers: Grayhill, Inc. Description: ROTARY ENCODER OPTICAL 32PPR In stock: 2460 pcs</p> <p>RFQ</p>	 <p>62S11-L0-060S Manufacturers: Grayhill, Inc. Description: ROTARY ENCODER OPTICAL 32PPR In stock: 2241 pcs</p> <p>RFQ</p>
 <p>62S11-L0-020CH Manufacturers: Grayhill, Inc. Description: ROTARY ENCODER OPTICAL 32PPR In stock: 2105 pcs</p> <p>RFQ</p>	 <p>62S11-L0-060CH Manufacturers: Grayhill, Inc. Description: ROTARY ENCODER OPTICAL 32PPR In stock: 1935 pcs</p> <p>RFQ</p>
 <p>62S11-H9-PH Manufacturers: Grayhill, Inc. Description: ROTARY ENCODER OPTICAL 32PPR In stock: 2090 pcs</p> <p>RFQ</p>	 <p>62S11-H9-P Manufacturers: Grayhill, Inc. Description: ROTARY ENCODER OPTICAL 32PPR In stock: 2159 pcs</p> <p>RFQ</p>
 <p>62S11-L0-060SH Manufacturers: Grayhill, Inc. Description: ROTARY ENCODER OPTICAL 32PPR In stock: 2073 pcs</p> <p>RFQ</p>	 <p>62S11-L0-P Manufacturers: Grayhill, Inc. Description: ROTARY ENCODER OPTICAL 32PPR In stock: 2100 pcs</p> <p>RFQ</p>

Copyright © 2020 Reliable Distributor of Electronic Components

E-mail: Info@infinity-electronic.com

Address: 17F, Gaylord Commercial Building, 114-118 Lockhart Road, Wan Chai, Hong Kong

