





Grayhill, Inc.

62S11-N5-100C

Part Number:	62S11-N5-100C
Manufacturer/Brand:	Grayhill, Inc.
Product description:	ROTARY ENCODER OPTICAL 32PPR
Datasheets:	 62S11-N5-100C.pdf
RoHS Status:	 Lead free / RoHS Compliant
Stock Condition:	1789 pcs stock
Ship From:	Hong Kong
Shipment Way:	DHL/Fedex/TNT/UPS/EMS



[REQUEST FOR QUOTATION](#)

Image may be representation. See specifications for product details.

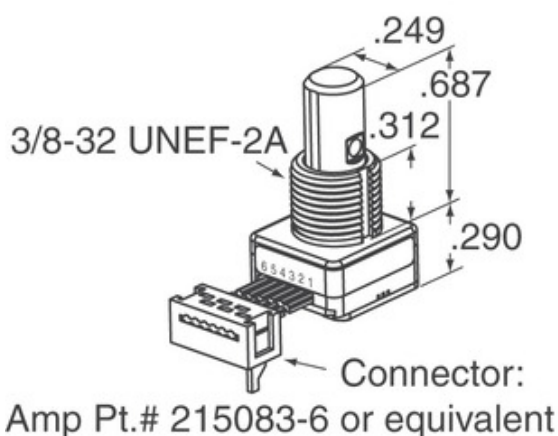

Specifications of 62S11-N5-100C

PART NUMBER	62S11-N5-100C
MANUFACTURER	Grayhill, Inc.
DESCRIPTION	ROTARY ENCODER OPTICAL 32PPR
LEAD FREE STATUS / ROHS STATUS	Lead free / RoHS Compliant
QUANTITY AVAILABLE	1789 pcs
DATA SHEET	 62S11-N5-100C.pdf
VOLTAGE - SUPPLY	5V
TERMINATION STYLE	Cable with Connector
SERIES	62S
ROTATIONAL LIFE (CYCLES MIN)	1M
PULSES PER REVOLUTION	32
OUTPUT TYPE	Quadrature (Incremental)
OTHER NAMES	62S11N5100C
ORIENTATION	Vertical
MOUNTING TYPE	Panel Mount
MOISTURE SENSITIVITY LEVEL (MSL)	1 (Unlimited)
LEAD FREE STATUS / ROHS STATUS	Lead free / RoHS Compliant
ENCODER TYPE	Optical
DETENT	No
BUILT IN SWITCH	Yes
ACTUATOR TYPE	1/4" Dia Flatted End

Related Tags

Grayhill, Inc. 62S11-N5-100C	62S11-N5-100C Distributor	62S11-N5-100C Supplier
62S11-N5-100C Price	62S11-N5-100C Pictures	62S11-N5-100C Image
62S11-N5-100C PDF Datasheet	62S11-N5-100C Download Datasheet	62S11-N5-100C Datasheet
62S11-N5-100C Stock	Buy 62S11-N5-100C	Buy Grayhill, Inc. 62S11-N5-100C
Grayhill, Inc. 62S11-N5-100C	Grayhill, Inc. Supplier	Grayhill, Inc. Distributor
Grayhill, Inc. 62S11-N5-100C	Grayhill Inc. 62S11-N5-100C	

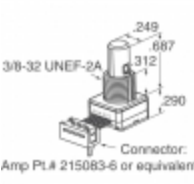
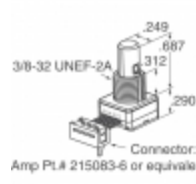
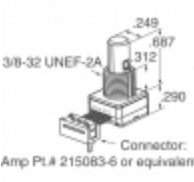
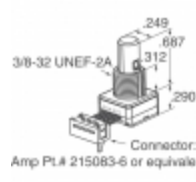
Related Products

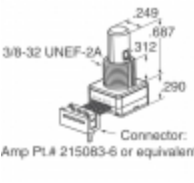
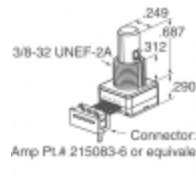
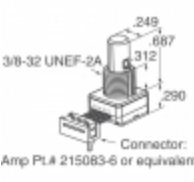
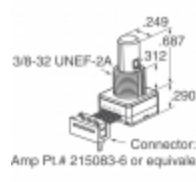
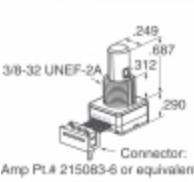
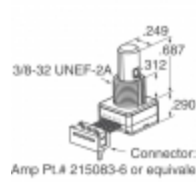
 <p>62S11-N5-120S Manufacturers: Grayhill, Inc. Description: ROTARY ENCODER OPTICAL 32PPR In stock: 1675 pcs</p> <p>RFQ</p>	 <p>62S11-N5-040C Manufacturers: Grayhill, Inc. Description: ROTARY ENCODER OPTICAL 32PPR In stock: 2106 pcs</p> <p>RFQ</p>
 <p>62S11-N9-060C Manufacturers: Grayhill, Inc. Description: ROTARY ENCODER OPTICAL 32PPR In stock: 2192 pcs</p> <p>RFQ</p>	 <p>62S11-N5-050C Manufacturers: Grayhill, Inc. Description: ROTARY ENCODER OPTICAL 32PPR In stock: 1936 pcs</p> <p>RFQ</p>
 <p>62S11-N5-PV Manufacturers: Grayhill, Inc. Description: ROTARY ENCODER OPTICAL 32PPR In stock: 2220 pcs</p> <p>RFQ</p>	 <p>62S11-N5-025CH Manufacturers: Grayhill, Inc. Description: ROTARY ENCODER OPTICAL 32PPR In stock: 2083 pcs</p> <p>RFQ</p>
 <p>62S11-N5-080SH Manufacturers: Grayhill, Inc. Description: ROTARY ENCODER OPTICAL 32PPR In stock: 1942 pcs</p> <p>RFQ</p>	 <p>62S11-N5-060C Manufacturers: Grayhill, Inc. Description: ROTARY ENCODER OPTICAL 32PPR In stock: 2164 pcs</p> <p>RFQ</p>
 <p>62S11-N5-060SH Manufacturers: Grayhill, Inc. Description: ROTARY ENCODER OPTICAL 32PPR In stock: 2263 pcs</p> <p>RFQ</p>	 <p>62S11-N9-060SH Manufacturers: Grayhill, Inc. Description: ROTARY ENCODER OPTICAL 32PPR In stock: 1801 pcs</p> <p>RFQ</p>
 <p>62S11-N9-120S Manufacturers: Grayhill, Inc. Description: ROTARY ENCODER OPTICAL 32PPR In stock: 1784 pcs</p> <p>RFQ</p>	 <p>62S11-N5-P Manufacturers: Grayhill, Inc. Description: ROTARY ENCODER OPTICAL 32PPR In stock: 1885 pcs</p> <p>RFQ</p>

Copyright © 2020 Reliable Distributor of Electronic Components

E-mail: Info@infinity-electronic.com

Address: 17F, Gaylord Commercial Building, 114-118 Lockhart Road, Wan Chai, Hong Kong

